

# Modular throttle valves type HQ, KQ, JPQ

flow control, ISO 4401 sizes 06, 10, 16 and 25

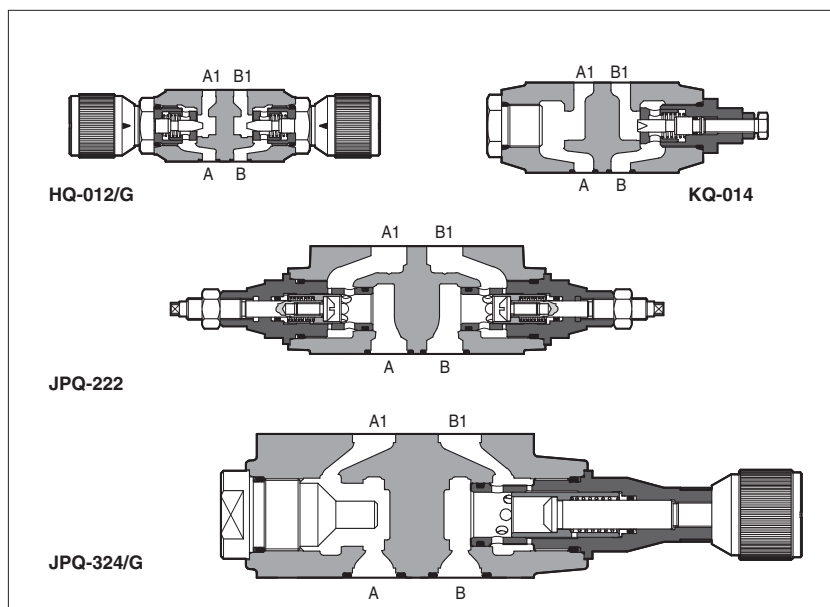

**HQ, KQ** and **JPQ** are flow throttling valves, not compensated, and with check valve to allow free flow in the opposite direction.

The flow adjustment is done by turning the setting screw in the normal model. Optional versions with a graduate micrometer knob are available on request. Clockwise rotation increases the throttling (passage reduced).

Valve size and max flow:

**HQ-0** = size 06, flow up to 25 l/min for /U option, up to 80 l/min for standard

**KQ-0** = size 10, flow up to 160 l/min

**JPQ-2** = size 16, flow up to 200 l/min

**JPQ-3** = size 25, flow up to 300 l/min

Mounting surface:

**ISO 4401 size 06, 10, 16 and 25**

Max pressure: **350 bar** (HQ, JPQ)  
**315 bar** (KQ)

## 1 MODEL CODE

<b>HQ-0</b>	<b>13</b>	/	<b>G</b>	<b>**</b>	/	<b>*</b>
<p>Modular flow control valve, size:  <b>HQ-0</b> = 06  <b>KQ-0</b> = 10  <b>JPQ-2</b> = 16  <b>JPQ-3</b> = 25</p>						<p>Seals material, see section 3:  <b>-</b> = NBR  <b>PE</b> = FKM  <b>BT</b> = HNBR</p>
<p>Configuration, see section 2  meter OUT control:  <b>12</b> = double, acting on port A and B  <b>13</b> = single, acting on port A  <b>14</b> = single, acting on port B  meter IN control:  <b>22</b> = double, acting on port A and B  <b>23</b> = single, acting on port A  <b>24</b> = single, acting on port B</p>			<p>Options:  <b>U</b> = better accuracy for reduced flow (only for HQ-0)  <b>G</b> = adjustment by graduated micrometer</p>			<p>Series number</p>

## 2 VALVE CONFIGURATION

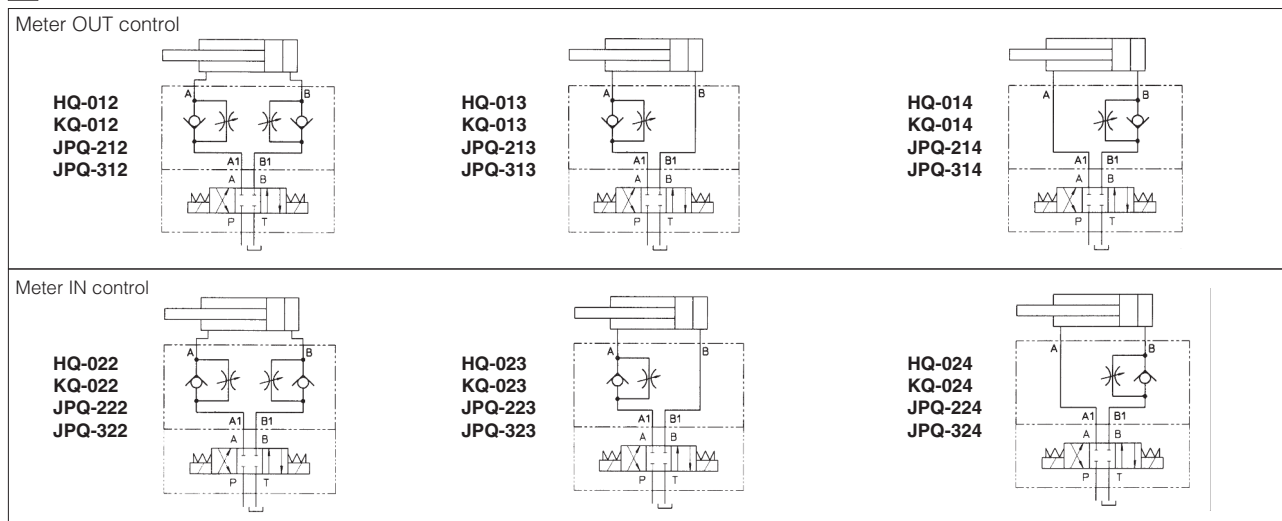

**3 MAIN CHARACTERISTICS, SEALS and HYDRAULIC FLUID** - for other fluids not included in below table, consult our technical office

Assembly position / location	Any position		
Subplate surface finishing	Roughness index Ra 0,4 - flatness ratio 0,01/100 (ISO 1101)		
MTTFd values according to EN ISO 13849	150 years, for further details see technical table P007		
Ambient temperature	Standard execution = -30°C ÷ +70°C /PE option = -20°C ÷ +70°C /BT option = -40°C ÷ +70°C		
Seals, recommended fluid temperature	NBR seals (standard) = -20°C ÷ +60°C, with HFC hydraulic fluids = -20°C ÷ +50°C FKM seals (/PE option) = -20°C ÷ +80°C HNBR seals (/BT option) = -40°C ÷ +60°C, with HFC hydraulic fluids = -40°C ÷ +50°C		
Recommended viscosity	15 ÷ 100 mm <sup>2</sup> /s - max allowed range 2.8 ÷ 500 mm <sup>2</sup> /s		
Fluid contamination class	ISO 4406 class 21/19/16 NAS 1638 class 10, in line filters of 25 µm (β25 ≥75 recommended)		
<b>Hydraulic fluid</b>	<b>Suitable seals type</b>	<b>Classification</b>	<b>Ref. Standard</b>
Mineral oils	NBR, FKM, HNBR	HL, HLP, HLPD, HVLP, HVLPD	DIN 51524
Flame resistant without water	FKM	HFDU, HFDR	ISO 12922
Flame resistant with water	NBR, HNBR	HFC	

**4 DIAGRAMS OF HQ-0** based on mineral oil ISO VG 46 at 50°C

- 1 = Regulation diagram at Δp 10 bar (1.1 = option /U)
- 2 = Regulation diagram at Δp 30 bar (2.1 = option /U)
- 3 = Regulation diagram at Δp 50 bar (3.1 = option /U)
- 4 = Q/Δp diagram for free flow through the non-return valve

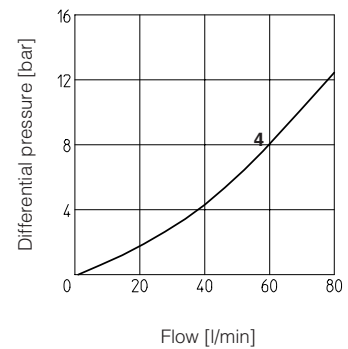
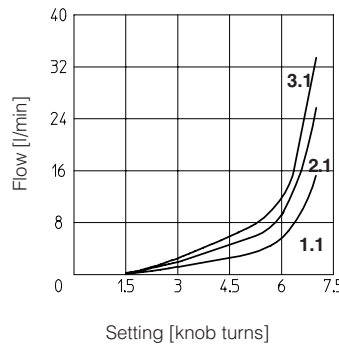
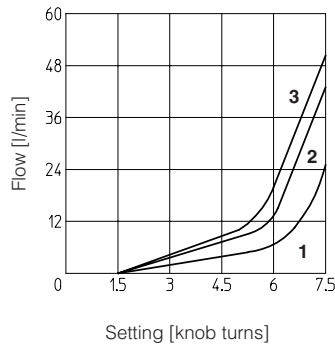

**5 DIAGRAMS OF KQ-0** based on mineral oil ISO VG 46 at 50°C

- 1 = Regulation diagram at Δp 10 bar
- 2 = Regulation diagram at Δp 30 bar
- 3 = Regulation diagram at Δp 50 bar
- 4 = Q/Δp diagram for free flow through the non-return valve

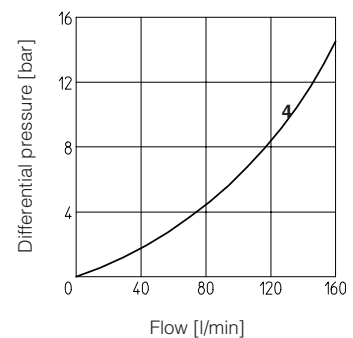
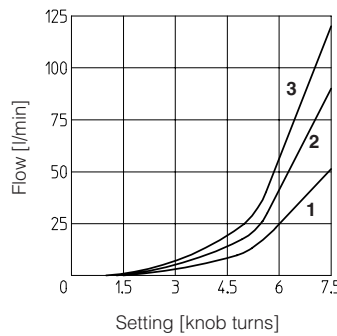

**6 DIAGRAMS OF JPQ-2** based on mineral oil ISO VG 46 at 50°C

- 1 = Regulation diagram at Δp 10 bar
- 2 = Regulation diagram at Δp 30 bar
- 3 = Regulation diagram at Δp 50 bar
- 4 = Q/Δp diagram for free flow through the non-return valve

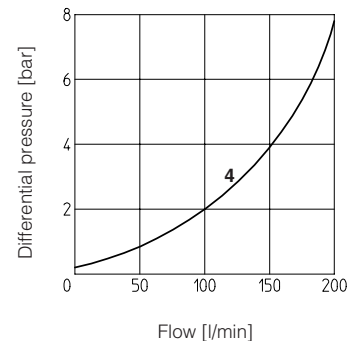
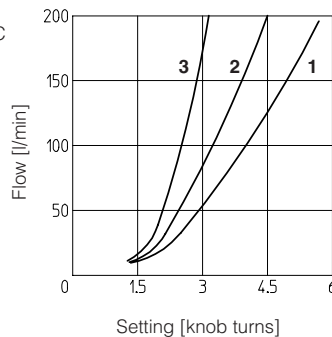

**7 DIAGRAMS OF JPQ-3** based on mineral oil ISO VG 46 at 50°C

- 1 = Regulation diagram at Δp 10 bar
- 2 = Regulation diagram at Δp 30 bar
- 3 = Regulation diagram at Δp 50 bar
- 4 = Q/Δp diagram for free flow through the non-return valve

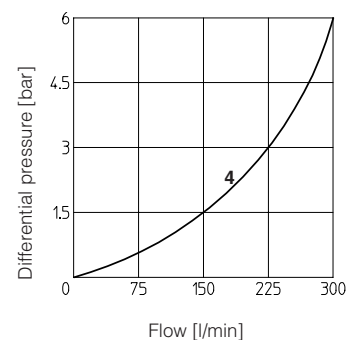
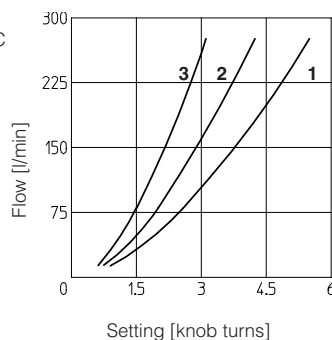

**8 INSTALLATION DIMENSIONS OF HQ-0 VALVES [mm]**

**HQ-012  
HQ-022**

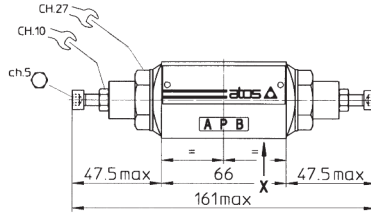
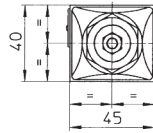

Mass: 1,1 Kg

**HQ-013  
HQ-014  
HQ-023  
HQ-024**

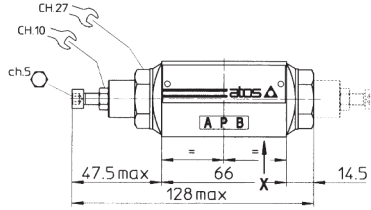
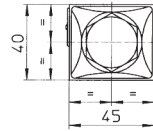

In version -014 and -024 the regulating element is on side of port B (dotted line) instead of side of port A.

Mass: 1,2 Kg

**/G OPTION**

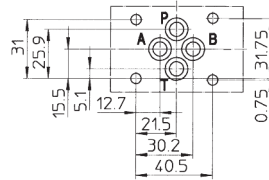
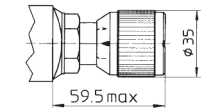
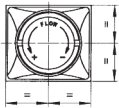

**ISO 4401: 2005**  
**Mounting surface: 4401-03-02-0-05**  
Diameter of ports A, B, P, T:  $\varnothing = 7,5$  mm (max)  
Seals: 4 OR 108

Fastening bolts: n° 4 socket head screws M5. The length depends on number and type of modular elements associated.

**9 INSTALLATION DIMENSIONS OF KQ-0 VALVES [mm]**

**KQ-012  
KQ-022**

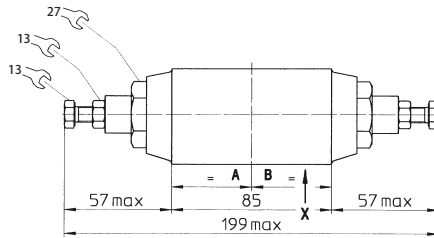
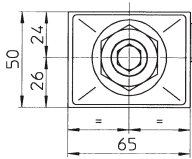

Mass: 2 Kg

**KQ-013  
KQ-014  
KQ-023  
KQ-024**

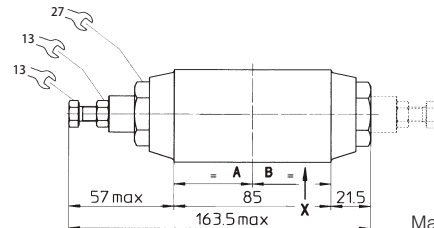
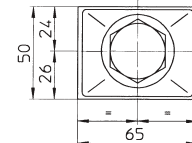

In version -014 and -024 the regulating element is on side of port B (dotted line) instead of side of port A.

Mass: 2,2 Kg

**/G OPTION**

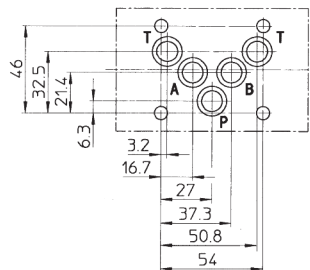
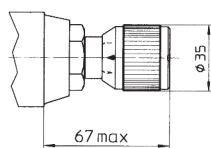
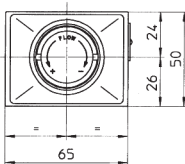

**ISO 4401: 2005**  
**Mounting surface: 4401-05-04-0-05**  
Diameter of ports, A, B, P, T:  $\varnothing = 11,2$  mm (max)  
Seals: 5 OR 2050

Fastening bolts: n° 4 socket head screws M6. The length depends on number and type of modular elements associated.

10 INSTALLATION DIMENSIONS OF JPQ-2 VALVES [mm]

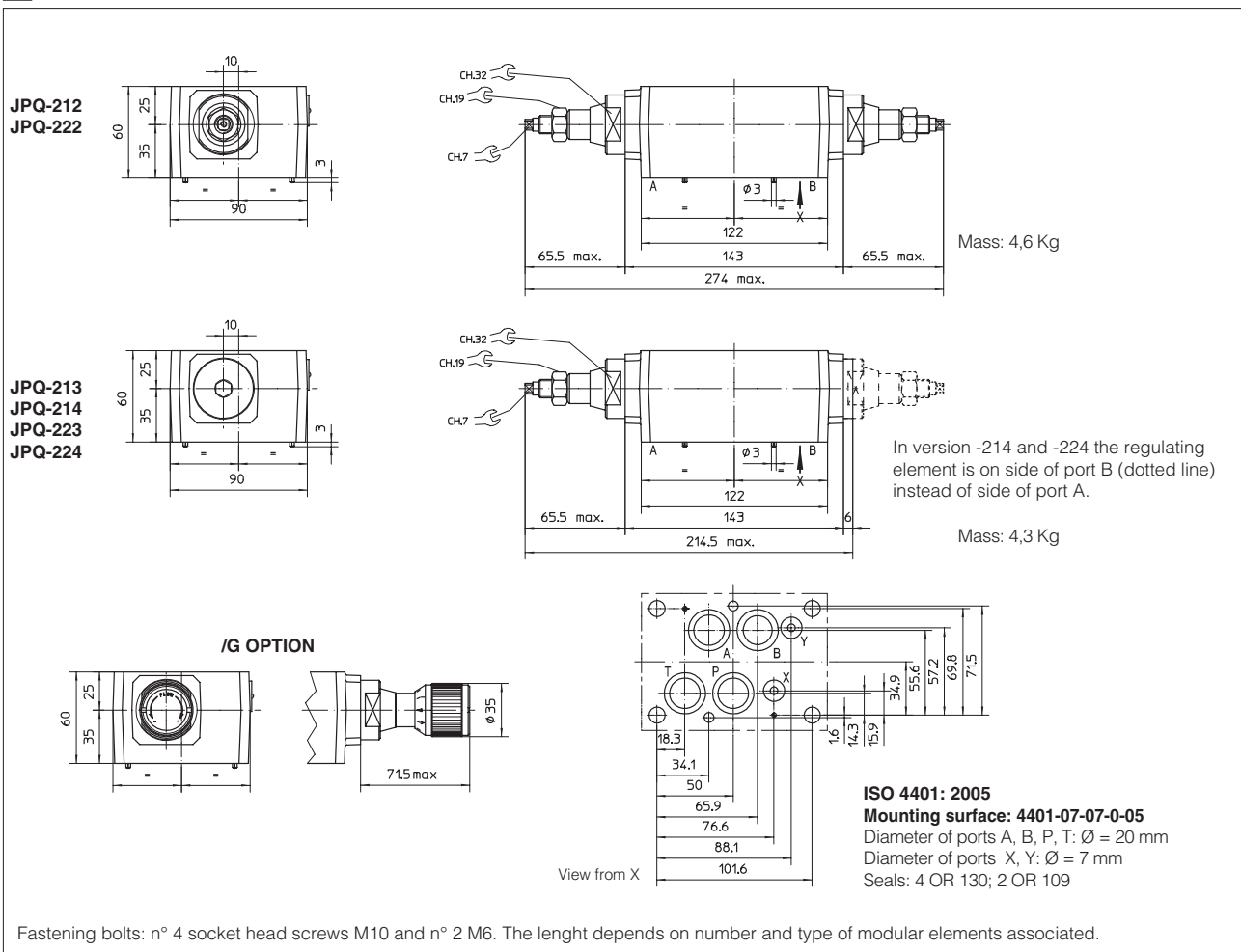

11 INSTALLATION DIMENSIONS OF JPQ-3 VALVES [mm]

