

Modular reducing valves type **HG, KG, JPG-2** and **JPG-3**

spool type, ISO 4401 sizes 06, 10, 16 and 25

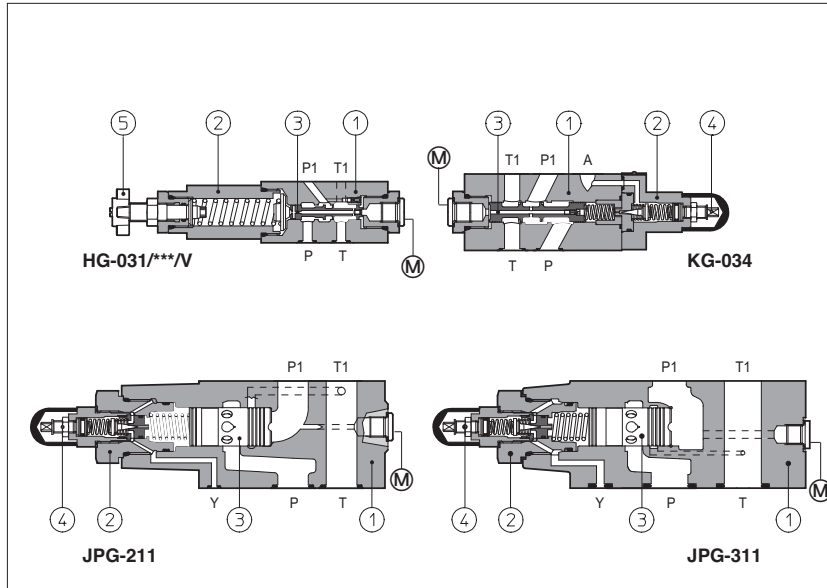

HG, KG, JPG are pressure reducing valves, spool type ③, designed to operate in oil hydraulic systems.

HG are direct, three way valves;
KG are double stage ① ②, three way valves;

JPG are double stage ① ②, two way valves.

Clockwise rotation increases the pressure.

Valve size and max flow:

HG = size 06 flow up to 50 l/min;

KG = size 10 flow up to 100 l/min;

JPG-2 = size 16 flow up to 250 l/min;

JPG-3 = size 25 flow up to 300 l/min;

Mounting surface:

ISO 4401 size 06, 10, 16 and 25

Max pressure: **350 bar** for HG

315 bar for KG and JPG

1 MODEL CODE

HG-0	31	/	210	/	V	/	**	/	*
Modular pressure reducing valve, size: HG-0 = 06 JPG-2 = 16 KG-0 = 10 JPG-3 = 25					Options: V = setting adjustment by handwheel instead of a grub screw protected by cap Only for HG: VF = regulating knob/ VS = regulating knob with safety locking		Series number		Seals material, see section ③: - = NBR PE = FKM BT = HNBR
Configuration, see section ② two way (only for JPG): 11 = reduced pressure on P port three way (only for HG-0 and KG-0): 31 = reduced pressure on P port 33 = reduced pressure on A port 34 = reduced pressure on B port			Pressure range HG 32 = 3 - 32 bar 100 = 20 - 100 bar 50 = 2 - 50 bar 210 = 50 - 210 bar 75 = 10 - 75 bar				Pressure range KG 100 = 7 - 100 bar 210 = 8 - 210 bar		Pressure range JPG 100 = 6 - 100 bar 210 = 70 - 210 bar

2 HYDRAULIC CHARACTERISTICS

Hydraulic configuration											
Valve model	HG-03*/32	HG-03*/50	HG-03*/75	HG-03*/100	HG-03*/210	KG-03*/100	KG-03*/210	JPG-211/100	JPG-211/210	JPG-311/100	JPG-311/210
Max flow [l/min]	50			100			250	300			
Pressure range [bar]	3 ÷ 32	2 ÷ 50	10 ÷ 75	20 ÷ 100	50 ÷ 210	7 ÷ 100	8 ÷ 210	6 ÷ 100	70 ÷ 210	6 ÷ 100	70 ÷ 210
Max inlet pressure [bar]	350			315			315	315			
Max pressure on port T [bar]	160			160			160	160			

3 MAIN CHARACTERISTICS, SEALS and HYDRAULIC FLUID - for other fluids not included in below table, consult our technical office

Assembly position / location	Any position		
Subplate surface finishing	Roughness index Ra 0,4 - flatness ratio 0,01/100 (ISO 1101)		
MTTFd values according to EN ISO 13849	150 years, for further details see technical table P007		
Ambient temperature	Standard execution = -30°C ÷ +70°C /PE option = -20°C ÷ +70°C /BT option = -40°C ÷ +70°C		
Seals, recommended fluid temperature	NBR seals (standard) = -20°C ÷ +60°C, with HFC hydraulic fluids = -20°C ÷ +50°C FKM seals (/PE option) = -20°C ÷ +80°C HNBR seals (/BT option) = -40°C ÷ +60°C, with HFC hydraulic fluids = -40°C ÷ +50°C		
Recommended viscosity	15 ÷ 100 mm ² /s - max allowed range 2.8 ÷ 500 mm ² /s		
Fluid contamination class	ISO 4406 class 21/19/16 NAS 1638 class 10, in line filters of 25 µm (β25 ≥75 recommended)		
Hydraulic fluid	Suitable seals type	Classification	Ref. Standard
Mineral oils	NBR, FKM, HNBR	HL, HLP, HLPD, HVLP, HVLPD	DIN 51524
Flame resistant without water	FKM	HFDU, HFDR	ISO 12922
Flame resistant with water	NBR, HNBR	HFC	

4 DIAGRAMS OF HG-03* based on mineral oil ISO VG 46 at 50°C

- 1** = regulated pressure variation versus flow:
- between use port and discharge port
- between inlet port and use port
- 2** = differential pressure variation versus flow between inlet port and use port
- 3** = differential pressure variation versus flow between use port and discharge port

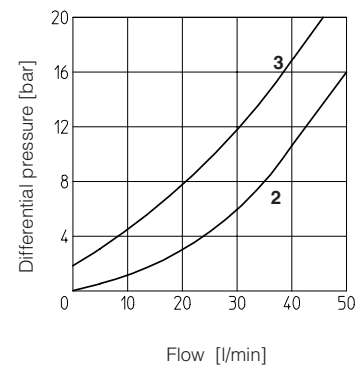
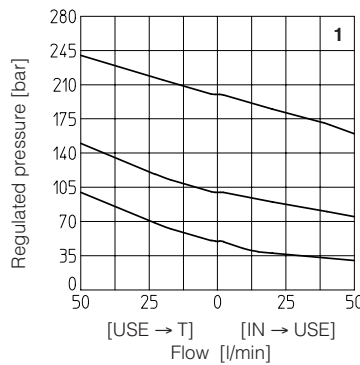

5 DIAGRAMS OF KG-03* based on mineral oil ISO VG 46 at 50°C

- 1** = regulated pressure variation versus flow:
- between use port and discharge port
- between inlet port and use port
- 2** = differential pressure variation versus flow between inlet port and use port
- 3** = differential pressure variation versus flow between use port and discharge port

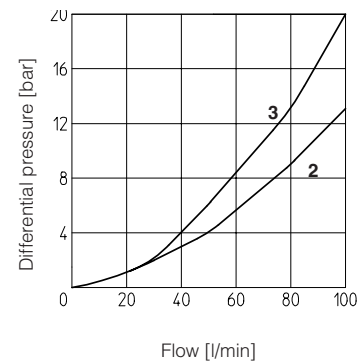
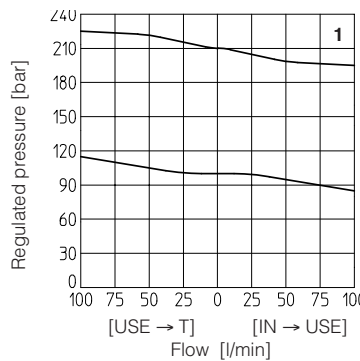

6 DIAGRAMS OF JPG-211 based on mineral oil ISO VG 46 at 50°C

- 1** = regulated pressure variation versus flow between inlet port and use port
- 2** = differential pressure variation versus flow between use port and discharge port

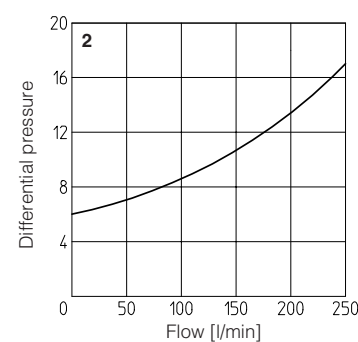
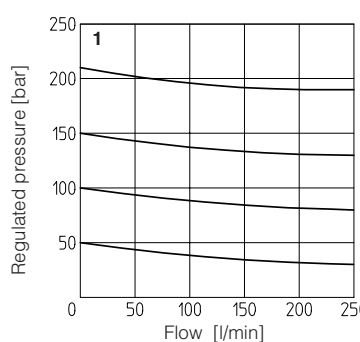

7 DIAGRAMS OF JPG-311 based on mineral oil ISO VG 46 at 50°C

- 1** = regulated pressure variation versus flow between inlet port and use port
- 2** = differential pressure variation versus flow between use port and discharge port

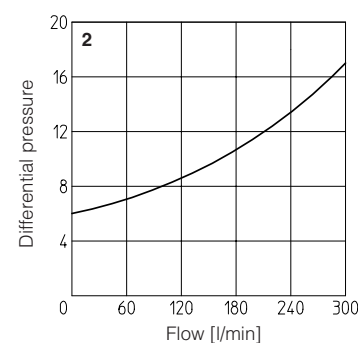
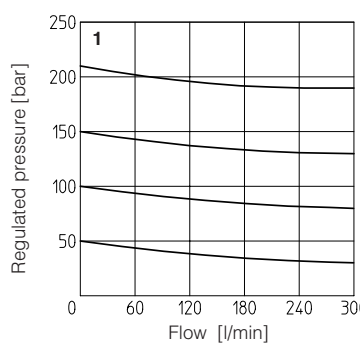

8 INSTALLATION DIMENSIONS OF HG-0 VALVES [mm]

HG-03*

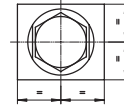
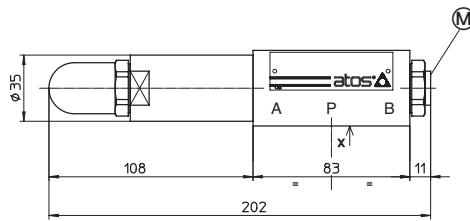
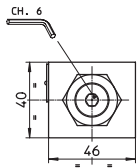

Ⓜ = Pressure gauge port = G 1/4"

Mass: 2,3 Kg

Adjustment device for option /V

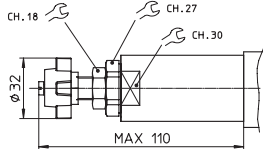

Adjustment device for option /VF and /VS

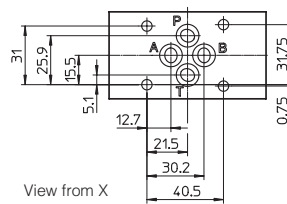
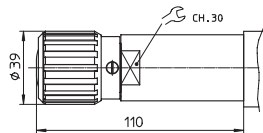

ISO 4401: 2005
Mounting surface: 4401-03-02-0-05
 Diameter of ports A, B, P, T: $\varnothing = 7,5$ mm
 Seals: 4 OR 108

Fastening bolts: n° 4 socket head screws M5. The length depends on number and type of modular elements associated.

9 INSTALLATION DIMENSIONS OF KG-0 VALVES [mm]

KG-03*

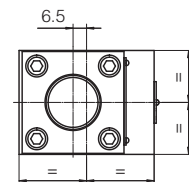
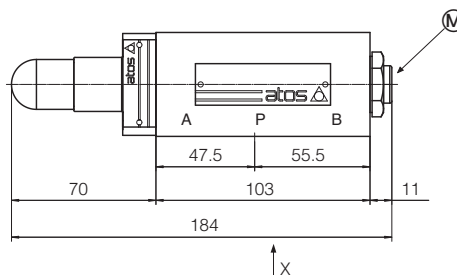
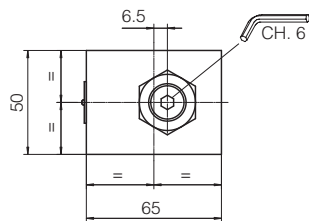

Ⓜ = Pressure gauge port = G 1/4"

Mass: 3,8 Kg

Adjustment device for option /V

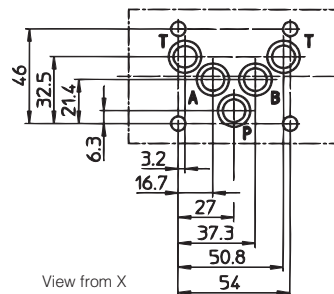
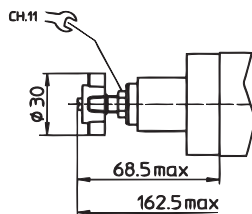

ISO 4401: 2005
Mounting surface: 4401-05-04-0-05
 Diameter of ports A, B, P, T: $\varnothing = 11,2$ mm
 Seals: 5 OR 2050

Fastening bolts: n° 4 socket head screws M6. The length depends on number and type of modular elements associated.

10 INSTALLATION DIMENSIONS OF JPG-2 VALVES [mm]

JPG-211

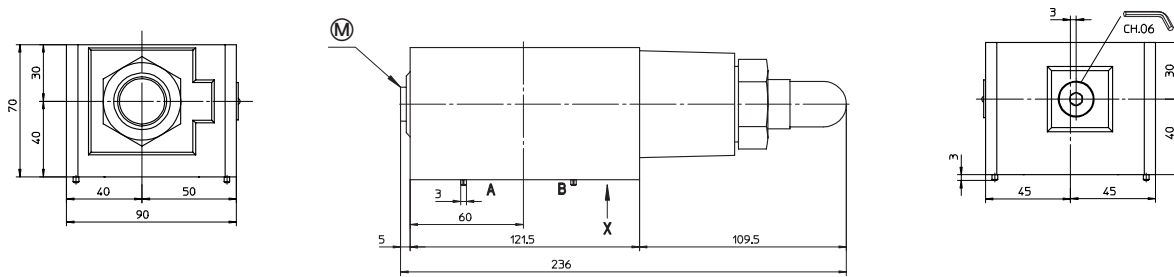

Ⓜ = Pressure gauge port = G 1/4"

Mass: 9 Kg

Adjustment device for option /V

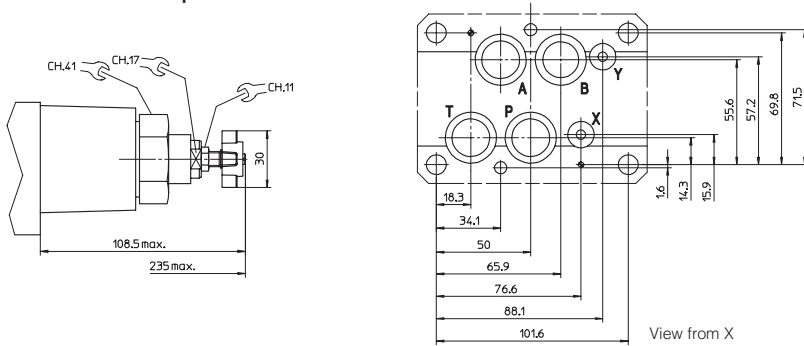

ISO 4401 : 2005
Mounting surface: 4401-07-07-0-05
 Diameter of ports A, B, P, T: $\varnothing = 20$ mm
 Diameter of ports X, Y: $\varnothing 7$ mm
 Seals: 4 OR 130: 2 OR 109

Fastening bolts: n° 4 socket head screws M10 and n° 2 M6. The length depends on number and type of modular elements associated.

11 INSTALLATION DIMENSIONS OF JPG-3 VALVES [mm]

JPG-311

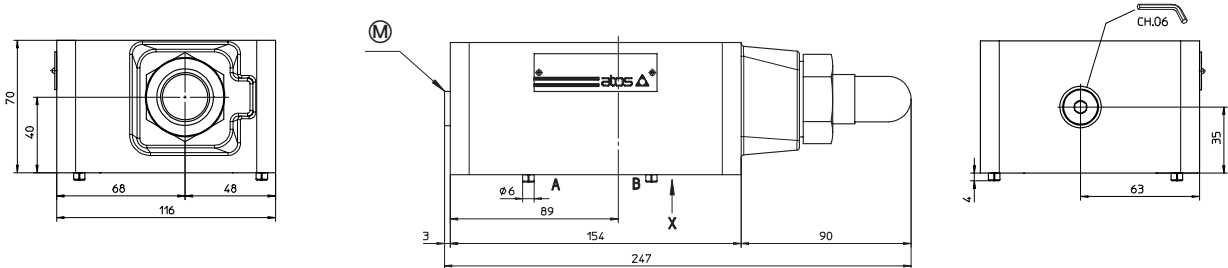

Ⓜ = Pressure gauge port = G 1/4"

Mass: 9 Kg

Adjustment device for option /V

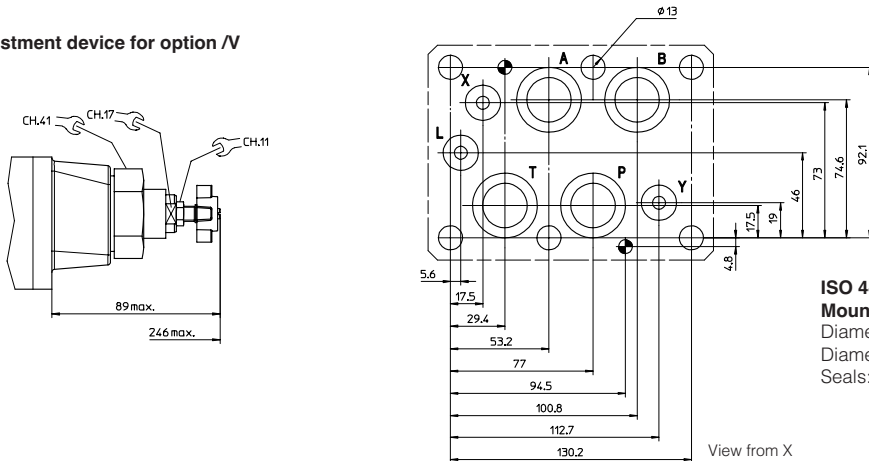

ISO 4401 : 2005
Mounting surface: 4401-08-08-0-05
 Diameter of ports A, B, P, T: $\varnothing = 24$ mm
 Diameter of ports X, Y: $\varnothing 7$ mm
 Seals: 4 OR 130: 2 OR 109

Fastening bolts: n° 6 socket head screws M12. The length depends on number and type of modular elements associated.