



FIXED DISPLACEMENT HYDRAULIC VANE PUMPS “HQ” SERIES

The design of the HQ series vane pumps makes them particularly suitable for application on trucks, especially garbage compactors.

All the components subject to wear are contained in a cartridge unit that can be easily removed for inspection and/or replacement without disconnecting the pump from the circuit, drastically reducing expensive machine downtime.

The special design of the inner flexible plates of the cartridge enables any thermal expansion in the rotor to be compensated for and to adequately cope with any sudden change in pressure.

Furthermore, the two opposed pumping chambers formed by the elliptical profile of the cam cancel out radial loads, dramatically reducing vibrations and considerably increasing the pump lifetime.

In addition to reliability, HQ pump guarantees continuous high volumetric efficiency during its whole servicetime. That avoids having to compensate the typical efficiency loss of other kinds of pump, increasing the truck engine RPM, which causes higher fuel consumption and therefore air pollution.

Such characteristics, along with an extremely low noise-level, make the HQ pump environmentally friendly, in line with the latest ecological trend.

The HQ series is available in 2 versions of single pump (from 39 to 88 l/min at 1000 rpm) and two versions of double pump (from 46 to 134 l/min at 1000 rpm) with maximum powers of over 103 kW. The pumps are extremely compact and are supplied with different types of either ISO or UNI norm mounting for the direct coupling with PTO and SAE norm hydraulic fittings. That, together with the possibility to orientate the inlet and outlet ports, makes the HQ pumps very easy to install and guarantees their interchangeability with other types of pumps.

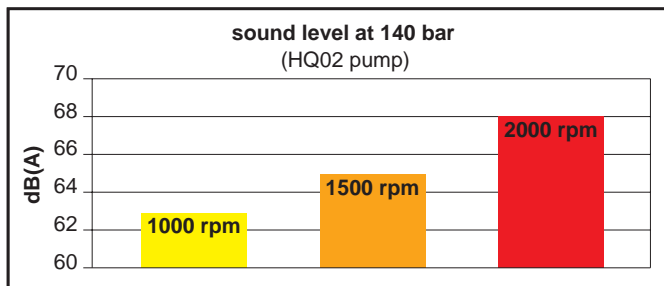

contents

Single pumps HQ02..... pag. 3

Single pumps HQ03..... pag. 10

Double pumps HQ21..... pag. 15

Double pumps HQ31..... pag. 25

Id. codes of cartridge kit components pag. 34

Operating instructions..... pag. 35

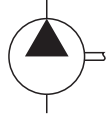
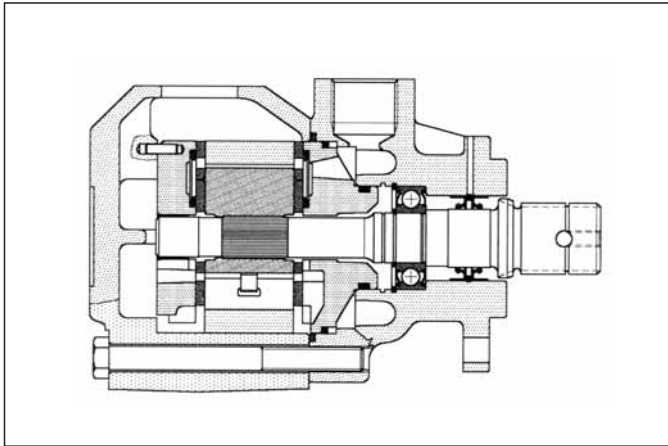

General description

Fixed displacement vane pump, hydraulically balanced, with capacity determined by the type of cartridge used and the speed of rotation. The pump is available in five different displacements from 39 to 66 l/min (from 10 to 17 gpm) at 1000 rpm and 7 bar.

Technical characteristics

Cartridge model	Geometric displacement		Rated capacity at 1000 rpm 7 bar		Rated capacity at 1200 rpm 7 bar		Rated capacity at 1500 rpm 7 bar		Maximum pressure with mineral oil		Speed range rpm	
	cm ³ /g	(in ³ /r)	l/min	(gpm)	l/min	(gpm)	l/min	(gpm)	bar	(psi)	min	max
A02-12	40,1	(2.45)	39,1	(10.0)	46,9	(12)	58,8	(15.5)	210	(3050)	600	2700
A02-14	45,4	(2.77)	43,9	(11.7)	52,7	(14)	65,7	(17.4)	210	(3050)	600	2700
A02-17	55,2	(3.37)	53,5	(14.2)	64,2	(17)	80,2	(21.2)	210	(3050)	600	2500
A02-19	60,1	(3.66)	59,2	(15.8)	71,1	(19)	88,7	(23.4)	210	(3050)	600	2500
A02-21	67,5	(4.12)	65,8	(17.5)	79,3	(21)	99,8	(26.4)	210	(3050)	600	2500

Hydraulic fluids: mineral oils, phosphate ester based fluids.

Viscosity range (with mineral oil): from 13 to 860 cSt. (13 to 54 cSt. recommended).

Filtration: for the inlet - 149 micron abs., for the return line - 25 micron abs. or better (with synthetic fluids: for the return line - 10 micron abs. or better).

Inlet pressure (with mineral oil): from -0,17 to +0,35 bar (-2.5 + 5 psi)

Operating temperature: with mineral oil -10°C to +70°C (+30°C to +60°C recommended).

Drive: direct and coaxial by means of a flexible coupling.

Main operating data

max pressure / hydraulic fluid

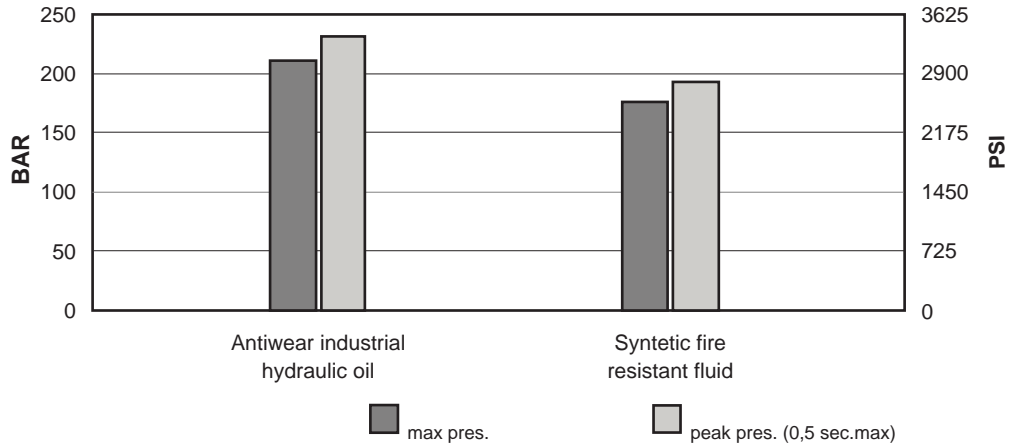

max speed / hydraulic fluid (with 0 bar in the intake pipe)

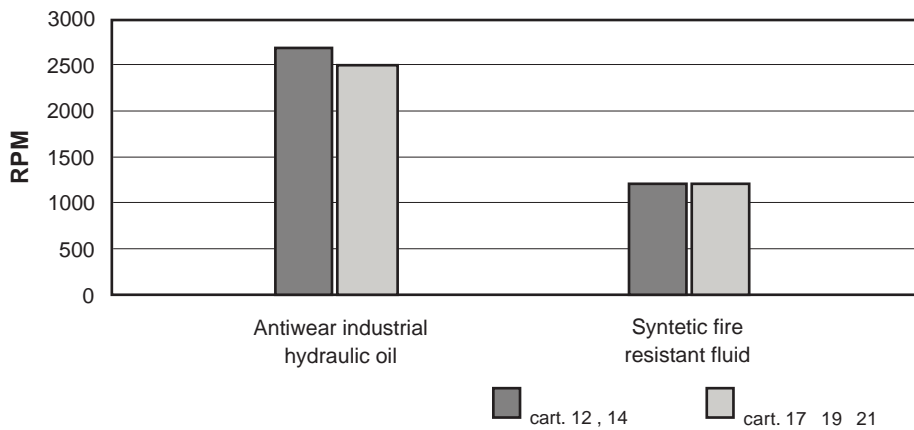

If the intake pressure is not zero bar, use the graph below to find the percentage correction factor to apply to the maximum speed.

max speed / intake pipe pressure

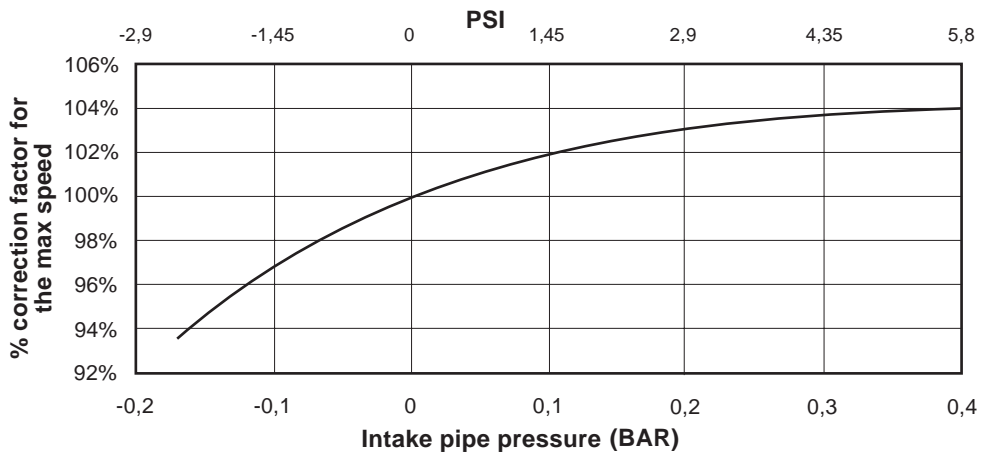

Cartridge A02-12

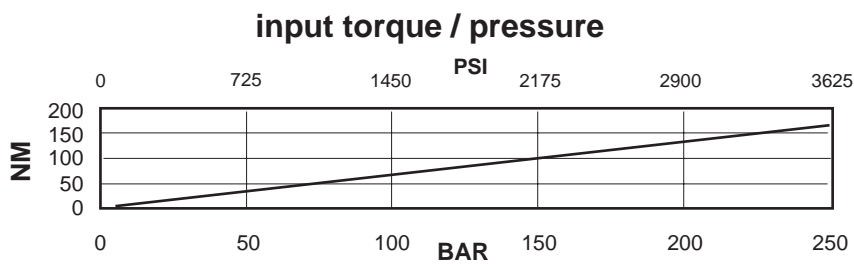
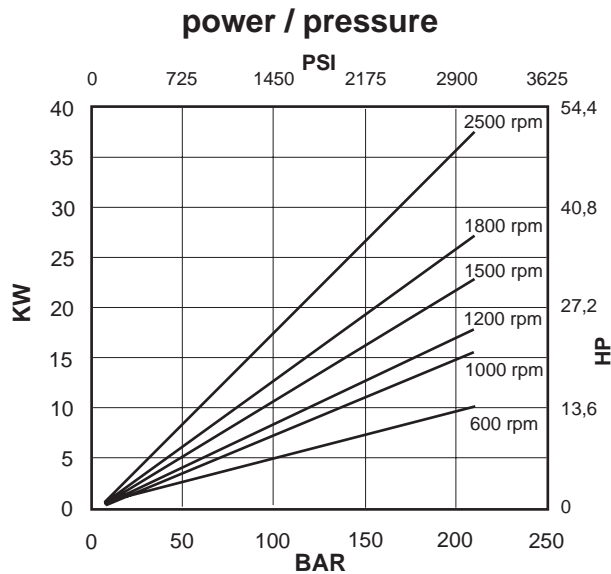
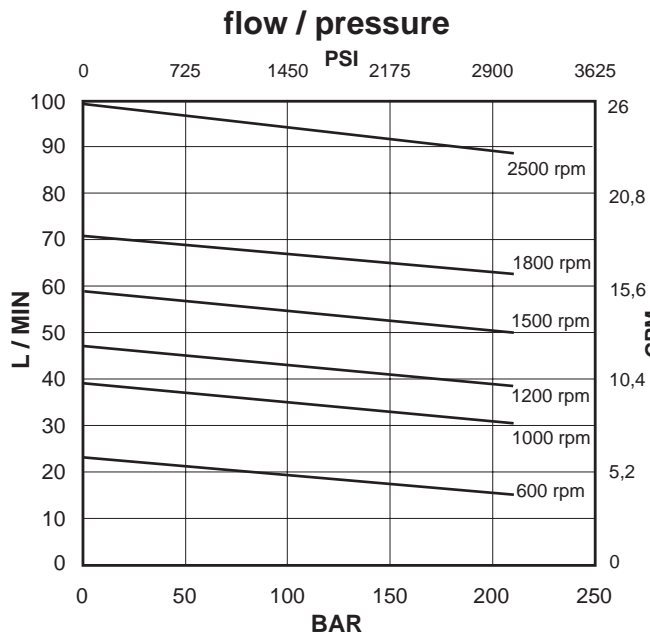

Oil viscosity: 25 c.St. (10W)
 Temperature: 45°C
 Inlet pressure: 0 BAR

Cartridge A02-14

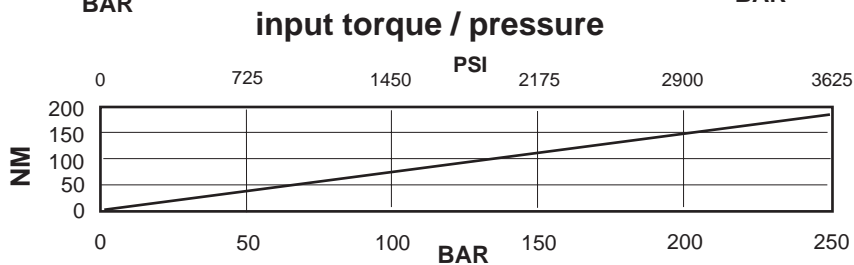
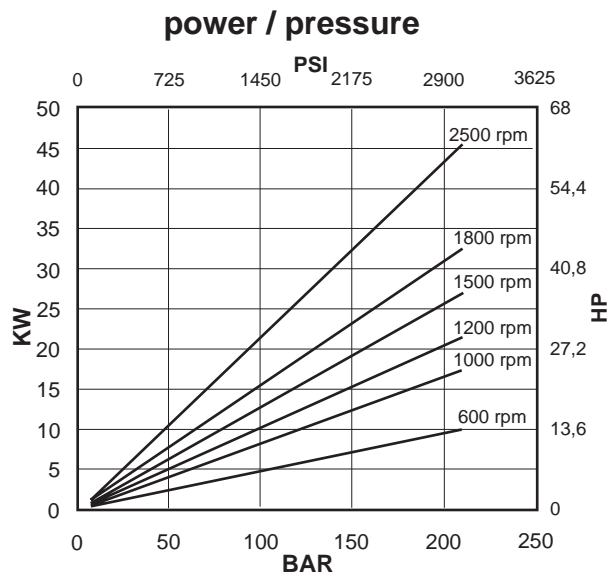
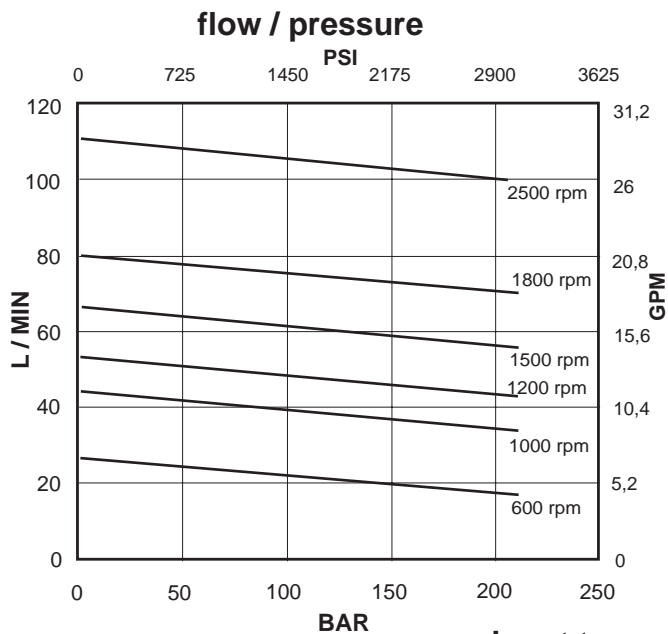

Oil viscosity: 25 c.St. (10W)
 Temperature: 45°C
 Inlet pressure: 0 BAR

Cartridge A02-17

flow / pressure

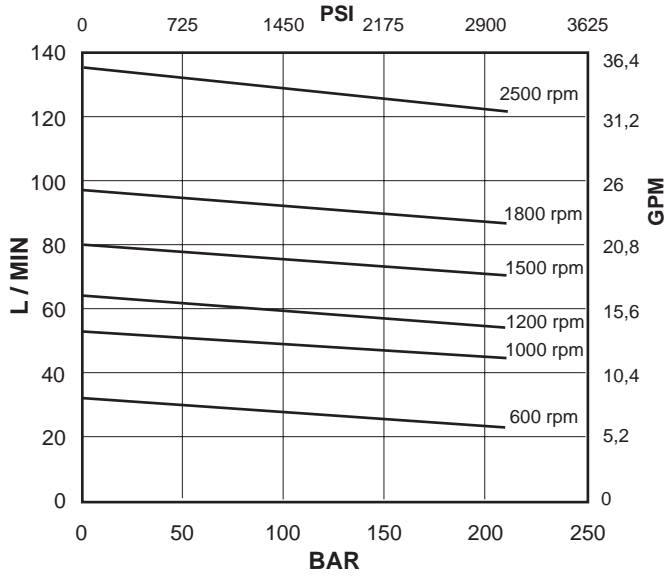

power / pressure

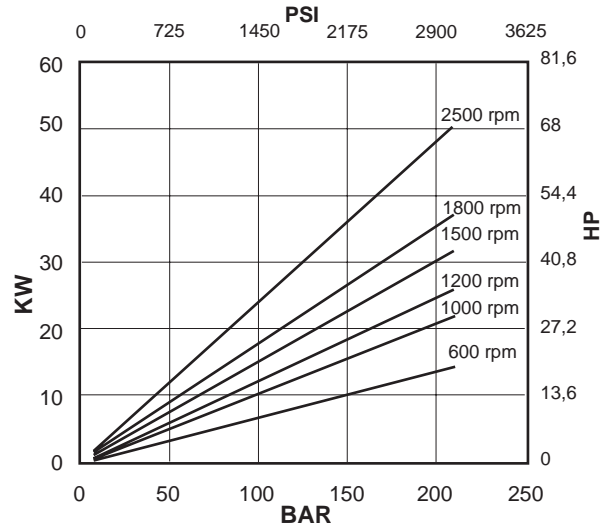

input torque / pressure

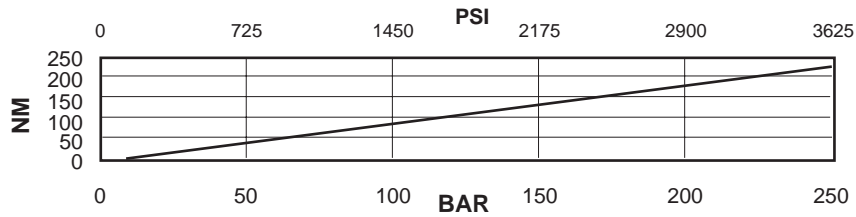

Oil viscosity: 25 c.St. (10W)
Temperature: 45°C
Inlet pressure: 0 BAR

Cartridge A02-19

flow / pressure

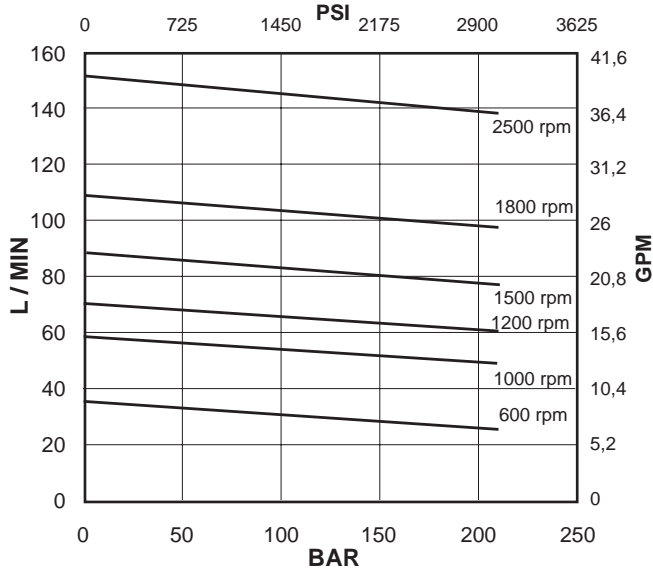

power / pressure

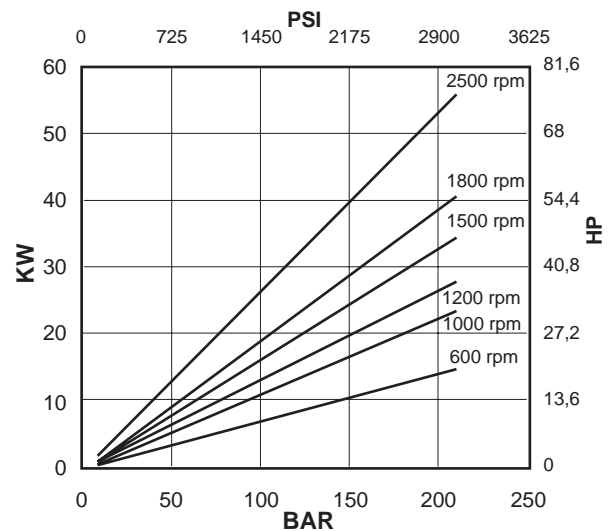

input torque / pressure

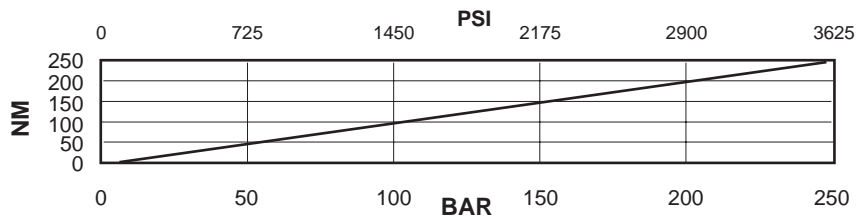

Oil viscosity: 25 c.St. (10W)
Temperature: 45°C
Inlet pressure: 0 BAR

Cartridge A02-21

flow / pressure

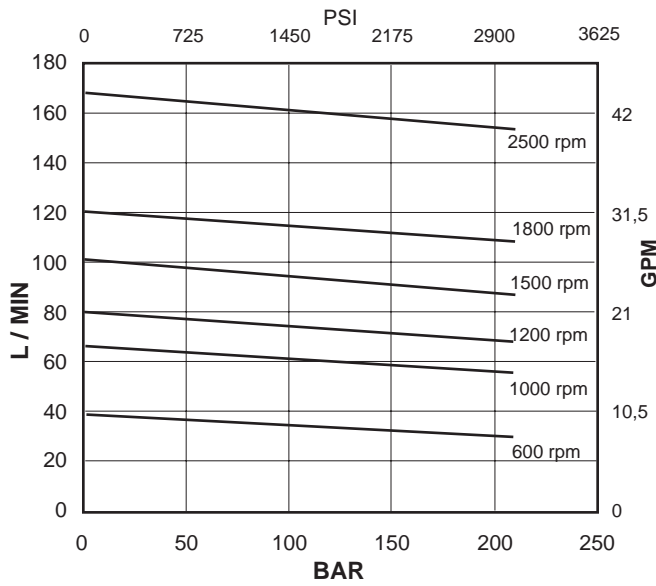

power / pressure

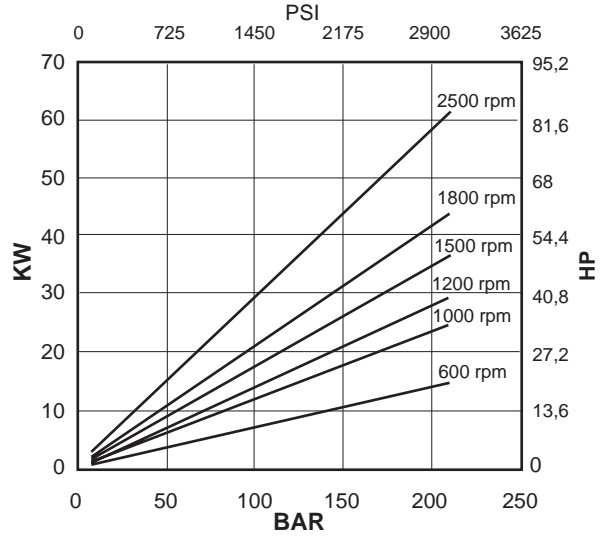

input torque / pressure

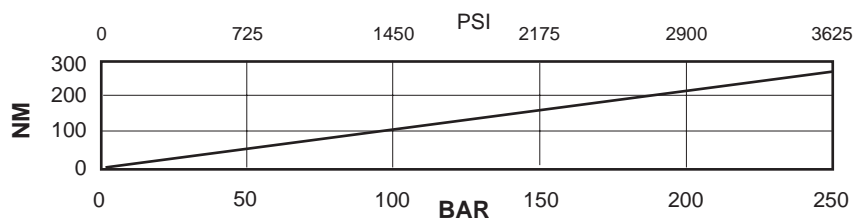

Oil viscosity: 25 c.St. (10W)
 Temperature: 45°C
 Inlet pressure: 0 BAR

Installation dimensions mm (inches)

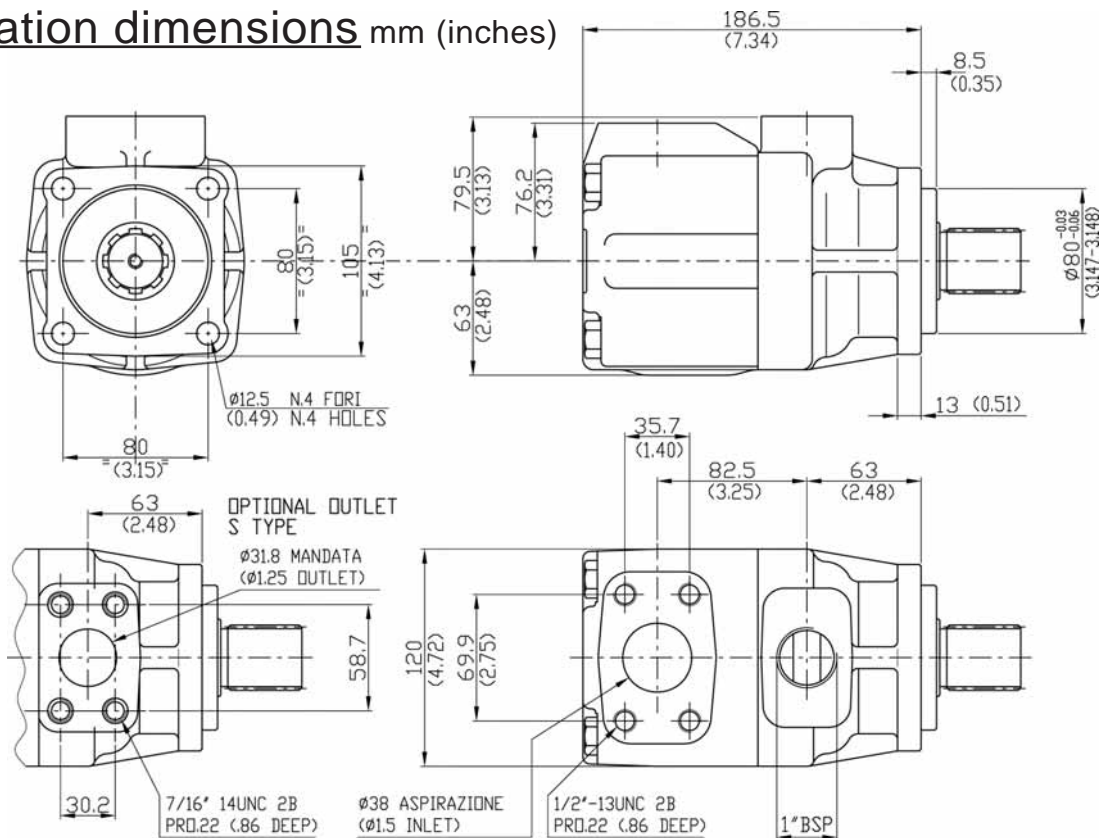

Approx. weight: 14,8 kg. (33 lbs.)

Model code breakdown

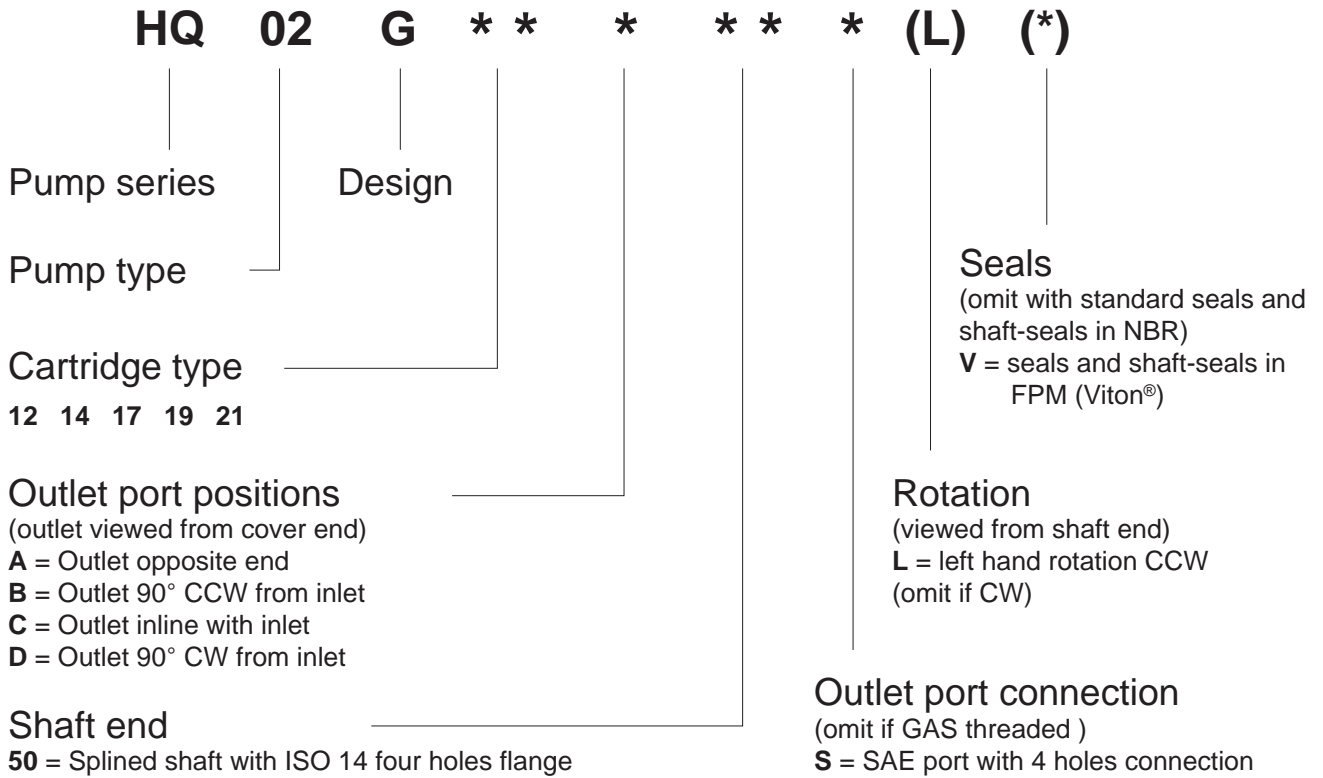

Shaft mm (inches)

Shaft 50

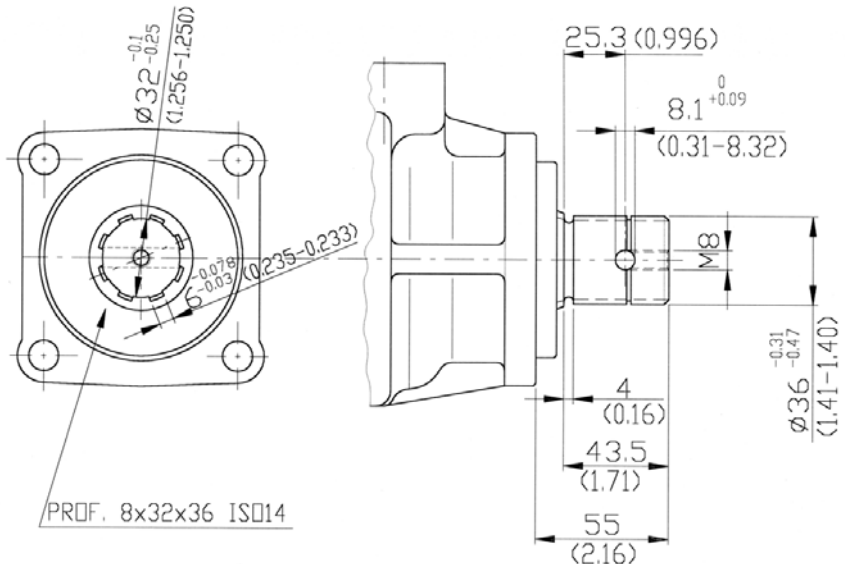

PORT ORIENTATIONS

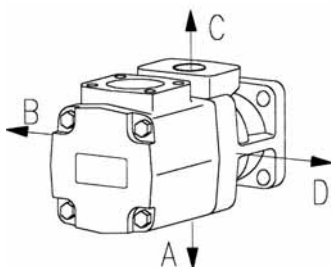

Id. codes of pump components

Cartridge		
Series	Model	PART NO. PUMP ROTAT.
A02	12	A0212030
	14	A0214070
	17	A0217110
	19	A0219150
	21	A0221190
A02	12	A0212040
	14	A0214080
	17	A0217120
	19	A0219160
	21	A0221200

Shaft kit	
Model	PART NO.
50	M6025000

Seeger	
PART NO.	M6000010

Shaft	
Model	PART NO.
50	K0250000

Body	
Model	PART NO.
STD	M8020016
S	M8020017

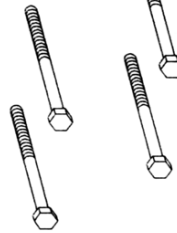
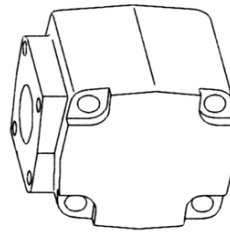
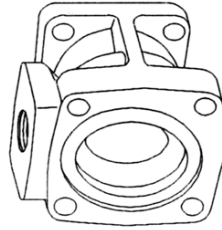

Bearing	
PART NO.	M8020030

Shaft seal	
PART NO.	Type
M8020060	NBR
M8020065	FPM

Seeger	
PART NO.	M8020050

Seeger	
PART NO.	M8020040

Cover	
PART NO.	M8020020

Screw	
PART NO.	M8020070
Torque to 102 Nm (910 lb. in.)	

Pump seal kit		
PART NO.	Parts	Type
M6025500	seals + 2 shaft seals	NBR
M6025510	seals + 2 shaft seals	FPM (Viton®)

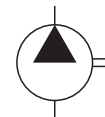
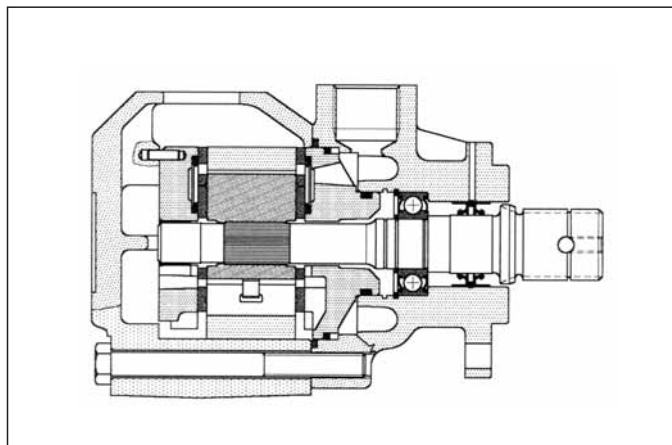

General description

Fixed displacement vane pump, hydraulically balanced, with capacity determined by the type of cartridge used and the speed of rotation. The pump is available in two different displacements from 75 to 88 l/min (from 20 to 23 gpm) at 1000 rpm and 7 bar.

Technical characteristics

Cartridge model	Geometric displacement		Rated capacity at 1000 rpm 7 bar		Rated capacity at 1200 rpm 7 bar		Rated capacity at 1500 rpm 7 bar		Maximum pressure with mineral oil		Speed range rpm	
	cm ³ /g	(in ³ /r)	l/min	(gpm)	l/min	(gpm)	l/min	(gpm)	bar	(psi)	min	max
A03-24	78,3	(4.78)	75,0	(20.0)	90	(24)	115,3	(30.5)	210	(3050)	600	2500
A03-28	91,2	(5.56)	88,3	(23.3)	106	(28)	131,8	(34.8)	210	(3050)	600	2500

Hydraulic fluids: mineral oils, phosphate ester based fluids.

Viscosity range (with mineral oil): from 13 to 860 cSt. (13 to 54 cSt. recommended).

Filtration: for the inlet - 149 micron abs., for the return line - 25 micron abs. or better (with synthetic fluids: for the return line - 10 micron abs. or better).

Inlet pressure (with mineral oil): from -0,17 to +0,35 bar (-2.5 + 5 psi)

Operating temperature: with mineral oil -10°C to +70°C (+30°C to +60°C recommended).

Drive: direct and coaxial by means of a flexible coupling.

Main operating data

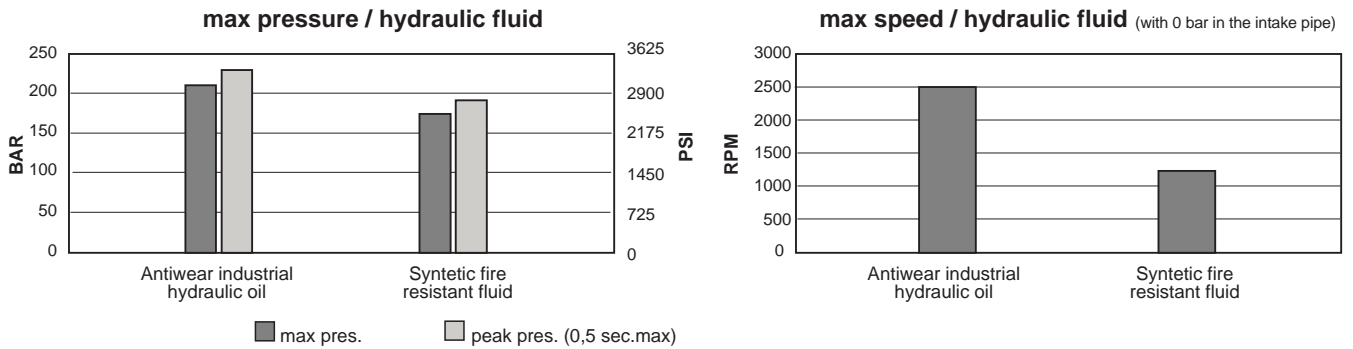

If the intake pressure is not zero bar, use the graph below to find the percentage correction factor to apply to the maximum speed.

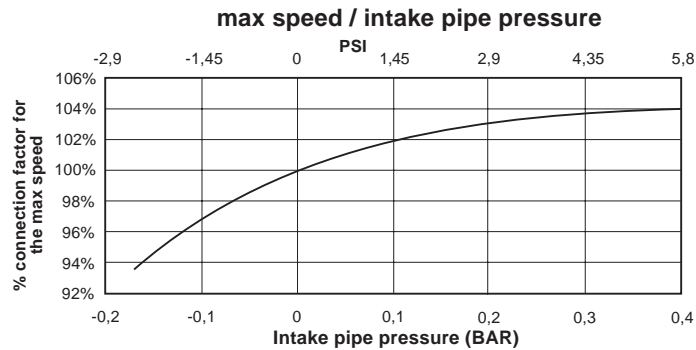

Cartridge A03-24

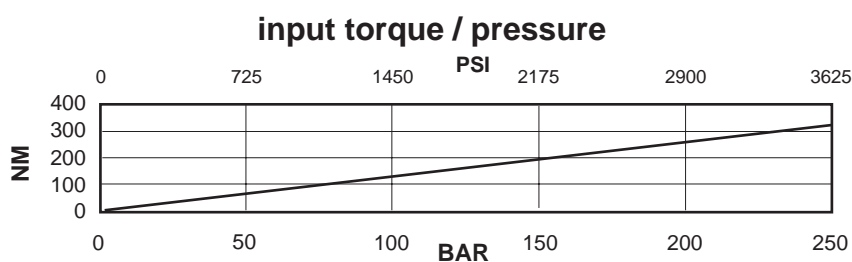
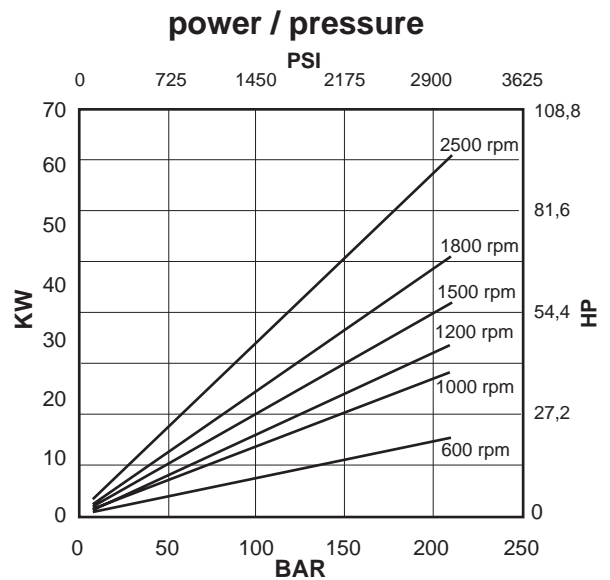
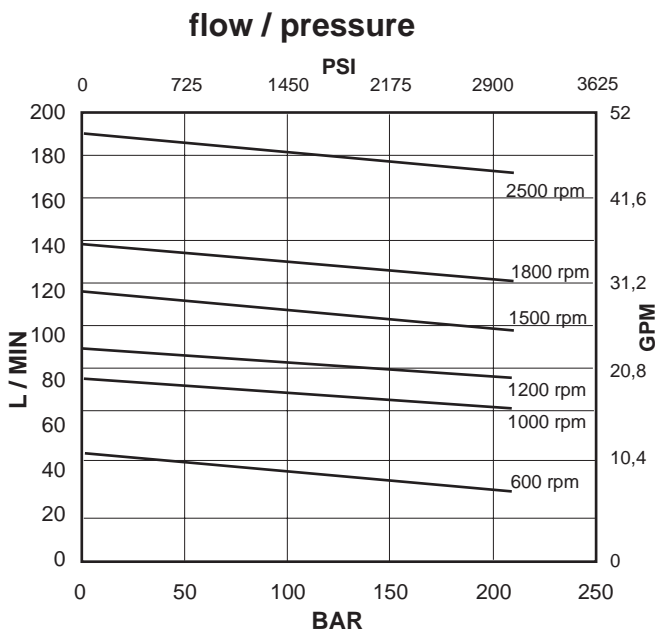

Oil viscosity: 25 c.St. (10W)
 Temperature: 45°C
 Inlet pressure: 0 BAR

Cartridge A03-28

flow / pressure

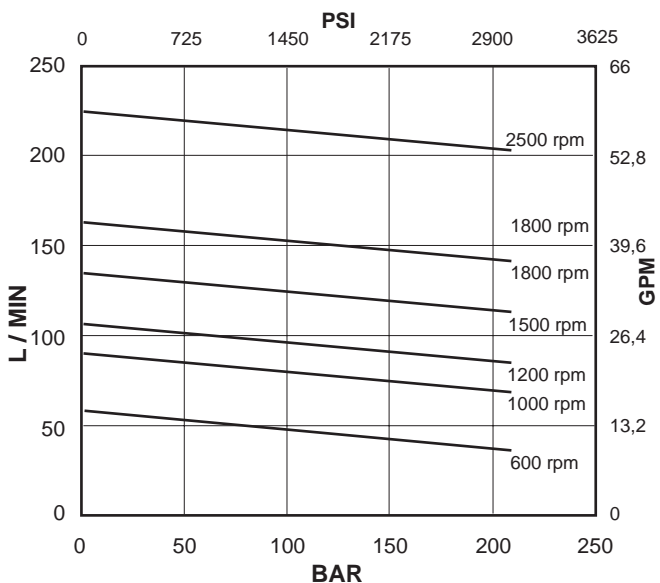

power / pressure

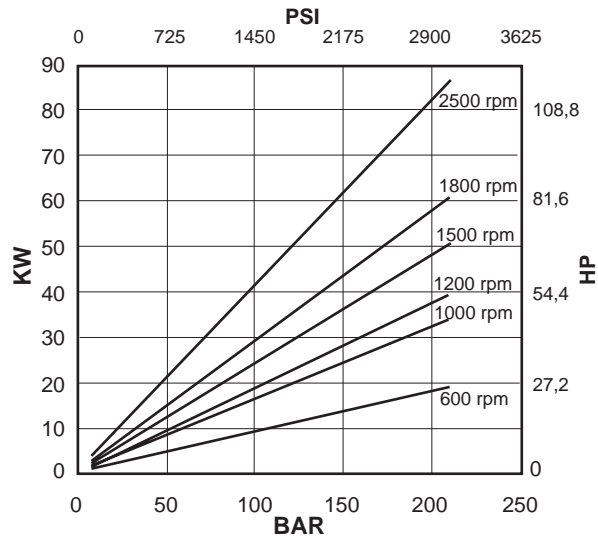

input torque / pressure

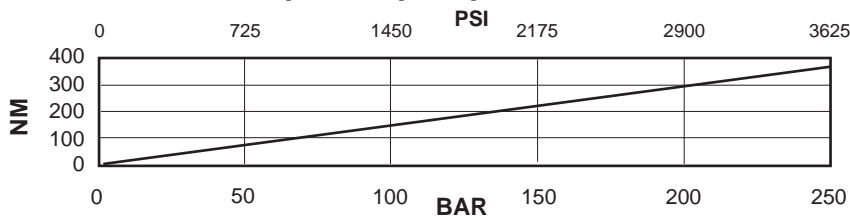

Oil viscosity: 25 c.St. (10W)
 Temperature: 45°C
 Inlet pressure: 0 BAR

Installation dimensions mm (inches)

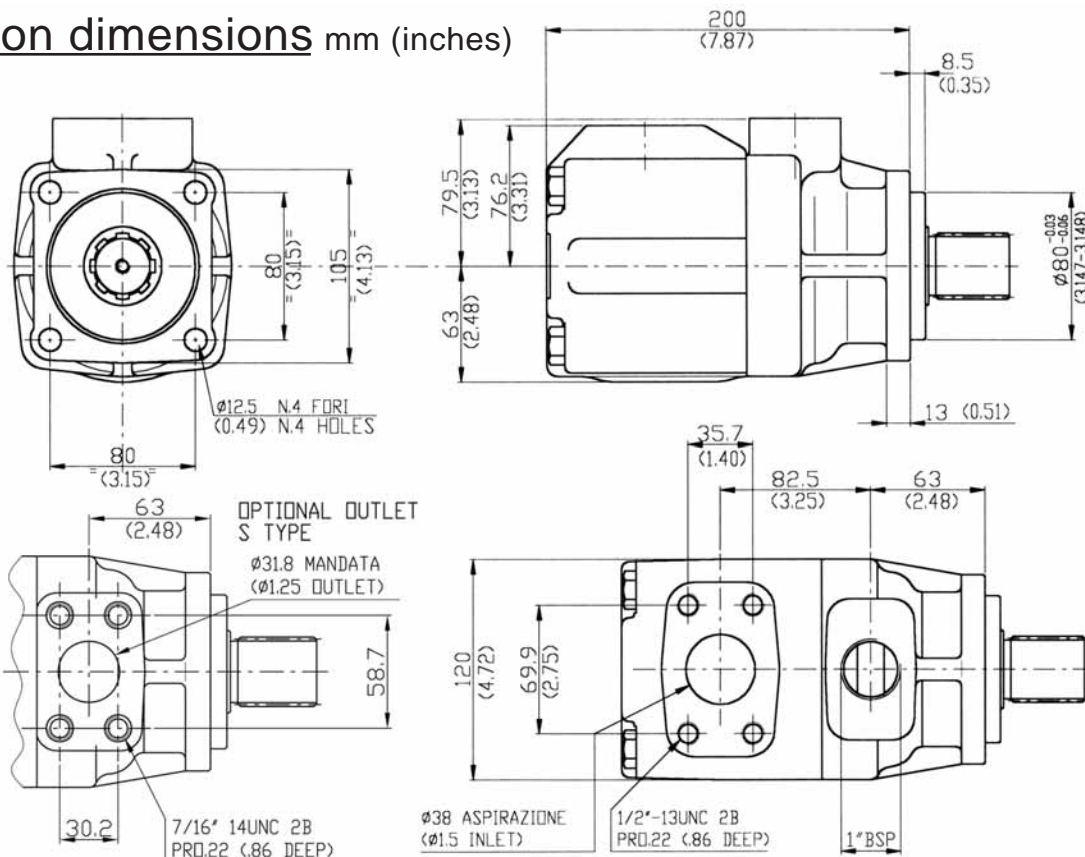

Approx. weight: 17 kg. (37 lbs.)

Model code breakdown

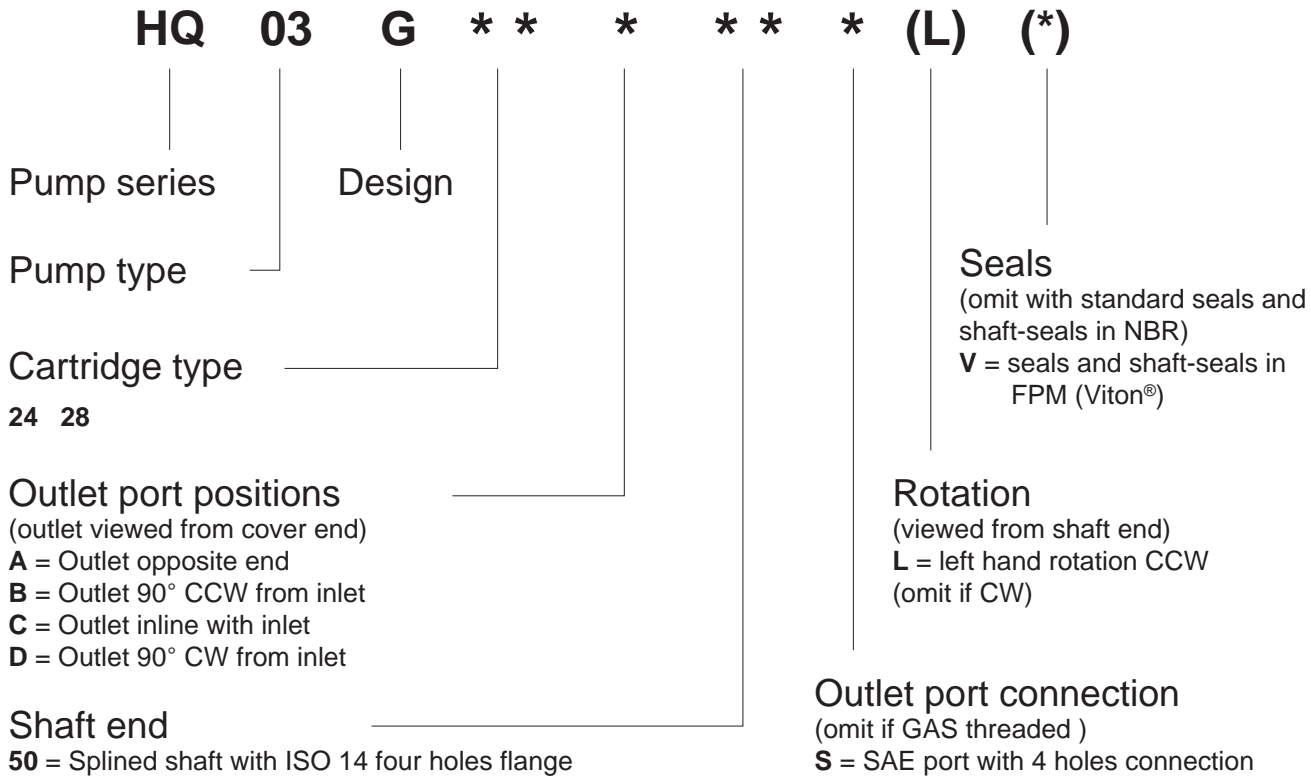

Shaft mm (inches)

Shaft 50

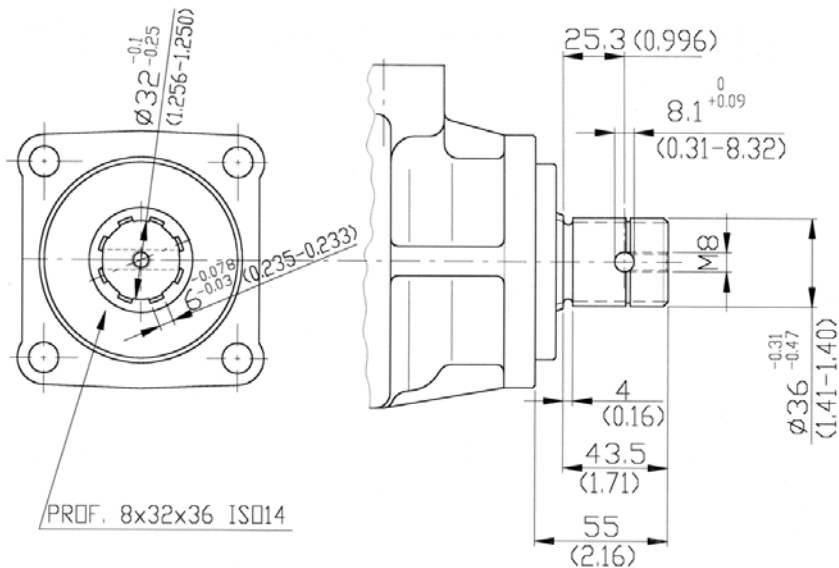

PORT ORIENTATIONS

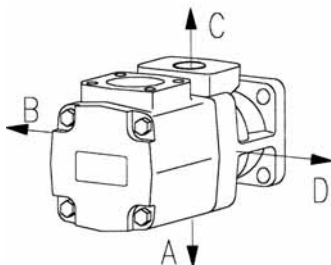



Id. codes of pump components

cartridge		
Series	Model	PART NO. PUMP ROTAT.
A03	24	A0324030
	28	A0328070
A03	24	A0324040
	28	A0328080

Shaft kit	
Model	PART NO.
50	M6035000

Seeger	
PART NO.	M6000010

Shaft	
Model	PART NO.
50	K0350000

Body	
Model	PART NO.
STD	M8020016
S	M8020017

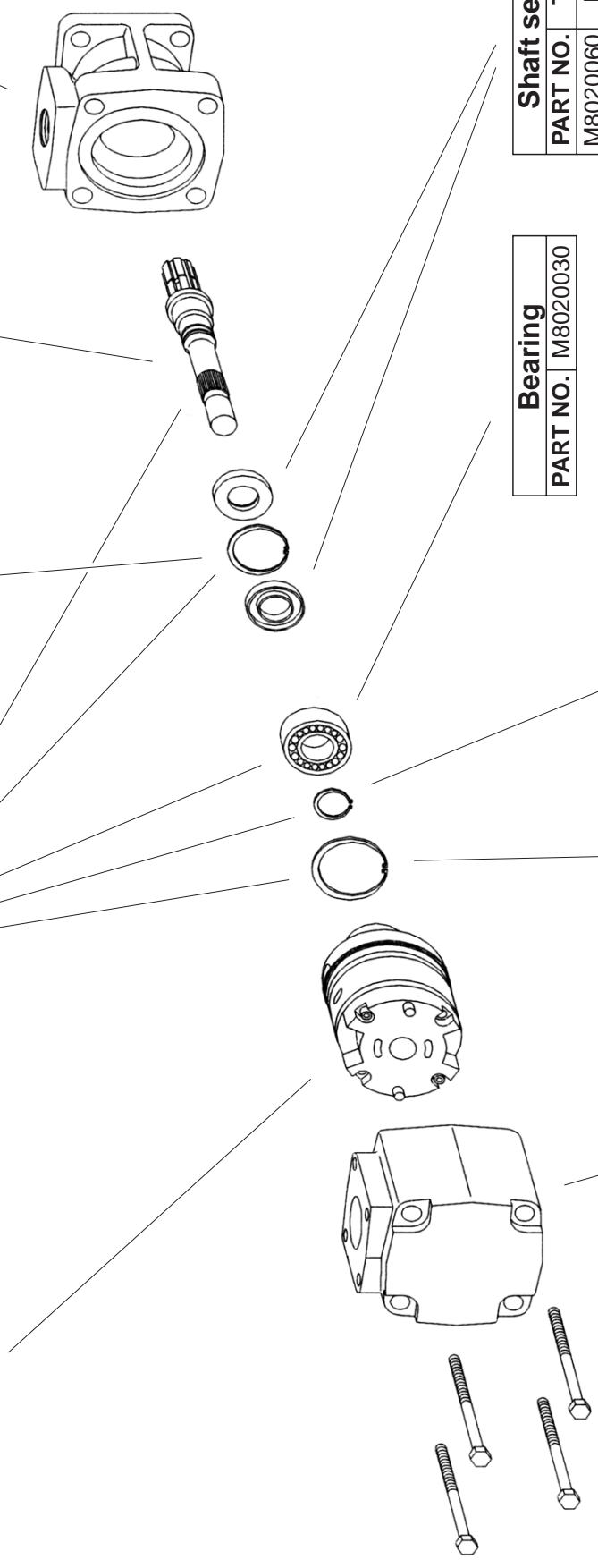

Shaft seal	
PART NO.	Type
M8020060	NBR
M8020065	FPM

Bearing	
PART NO.	M8020030

Seeger	
PART NO.	M8020050

Pump seal kit		
PART NO.	Parts	Type
M6025500	seals + 2 shaft seals	NBR
M6025510	seals + 2 shaft seals	FPM (Viton®)

Seeger	
PART NO.	M8020040

Cover	
PART NO.	M8030020

Screw	
PART NO.	M8020090
Torque to 102 Nm (910 lb. in.)	

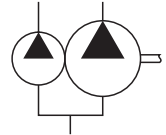
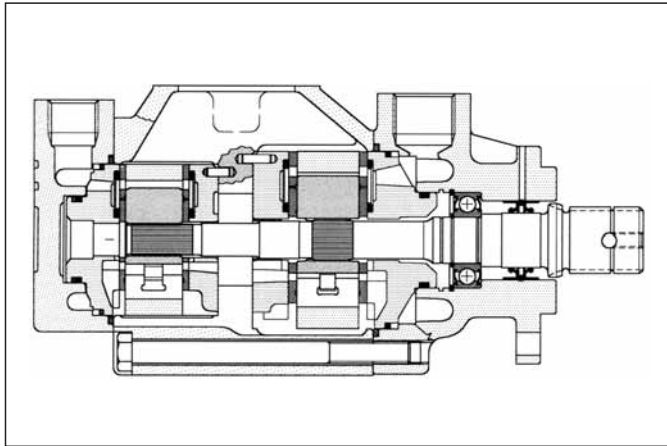

General description

Fixed displacement vane pump, hydraulically balanced, with capacity determined by the type of cartridge used and the speed of rotation. The pump is available in several versions with rated capacities from 46 to 111 l/min (from 12 to 29 gpm) at 1000 rpm and 7 bar.

Technical characteristics

Cartridge model	Geometric displacement		Rated capacity at 1000 rpm 7 bar		Rated capacity at 1200 rpm 7 bar		Rated capacity at 1500 rpm 7 bar		Maximum pressure with mineral oil		Speed range rpm	
	cm ³ /g	(in ³ /r)	l/min	(gpm)	l/min	(gpm)	l/min	(gpm)	bar	(psi)	min	max
shaft end												
A02-12	40,1	(2.45)	39,1	(10.0)	46,9	(12)	58,8	(15.5)	210	(3050)	600	2700
A02-14	45,4	(2.77)	43,9	(11.7)	52,7	(14)	65,7	(17.4)	210	(3050)	600	2700
A02-17	55,2	(3.37)	53,5	(14.2)	64,2	(17)	80,2	(21.2)	210	(3050)	600	2500
A02-19	60,1	(3.66)	59,2	(15.8)	71,1	(19)	88,7	(23.4)	210	(3050)	600	2500
A02-21	67,5	(4.12)	65,8	(17.5)	79,3	(21)	99,8	(26.4)	210	(3050)	600	2500
cover end												
A01-02	7,2	(0.44)	6,9	(1.7)	8,3	(2)	10,4	(2.8)	210	(3050)	600	2700
A01-05	18,1	(1.10)	17,3	(4.2)	20,8	(5)	26,1	(6.9)	210	(3050)	600	2700
A01-08	27,4	(1.67)	26,5	(6.7)	31,8	(8)	39,4	(10.4)	210	(3050)	600	2700
A01-09	30,1	(1.83)	29,2	(7.5)	35,1	(9)	44,1	(11.7)	210	(3050)	600	2700
A01-11	36,4	(2.22)	35,3	(9.2)	42,4	(11)	52,6	(13.9)	210	(3050)	600	2700
A01-12	39,5	(2.41)	39,1	(10.0)	46,9	(12)	58,7	(15.5)	160	(2300)	600	2700
A01-14	45,9	(2.79)	45,8	(11.7)	54,9	(14)	69,6	(18.4)	140	(2030)	600	2700

Hydraulic fluids: mineral oils, phosphate ester based fluids.

Viscosity range (with mineral oil): from 13 to 860 cSt. (13 to 54 cSt. recommended).

Filtration: for the inlet - 149 micron abs., for the return line - 25 micron abs. or better (with synthetic fluids: for the return line - 10 micron abs. or better).

Inlet pressure (with mineral oil): from -0,17 to +0,35 bar (-2.5 + 5 psi)

Operating temperature: with mineral oil -10°C to +70°C (+30°C to +60°C recommended).

Drive: direct and coaxial by means of a flexible coupling.

Main operating data

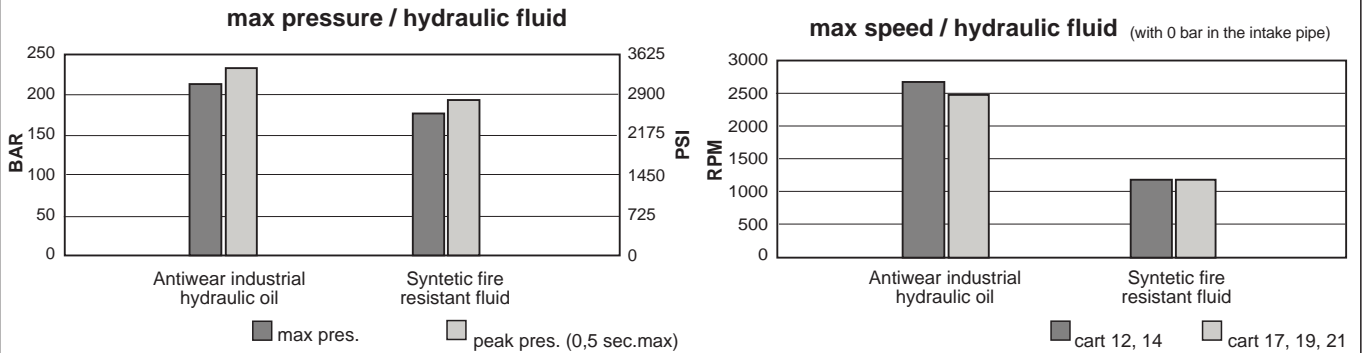

If the intake pressure is not zero bar, use the graph below to find the percentage correction factor to apply to the maximum speed.

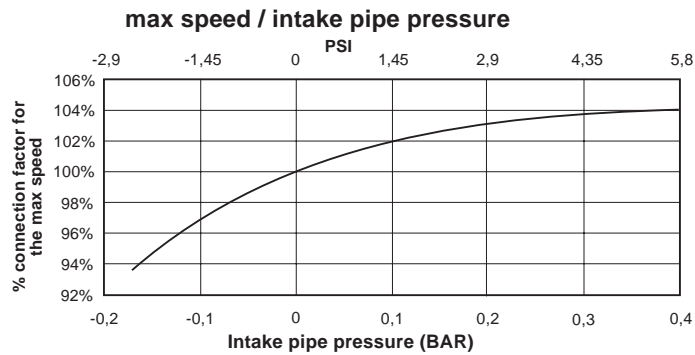

Shaft end cartridge A02-12

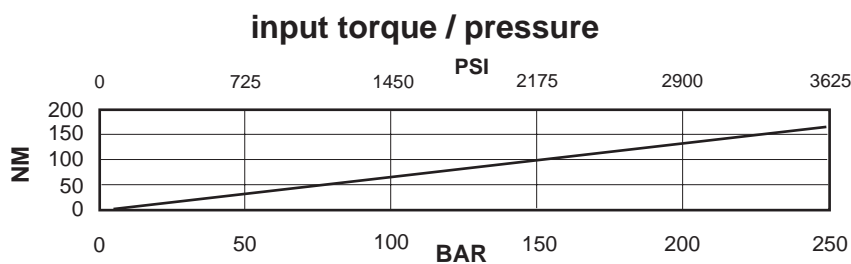
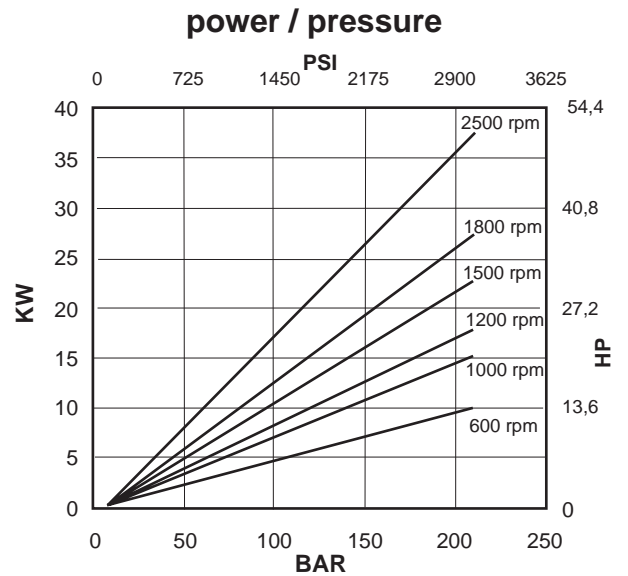
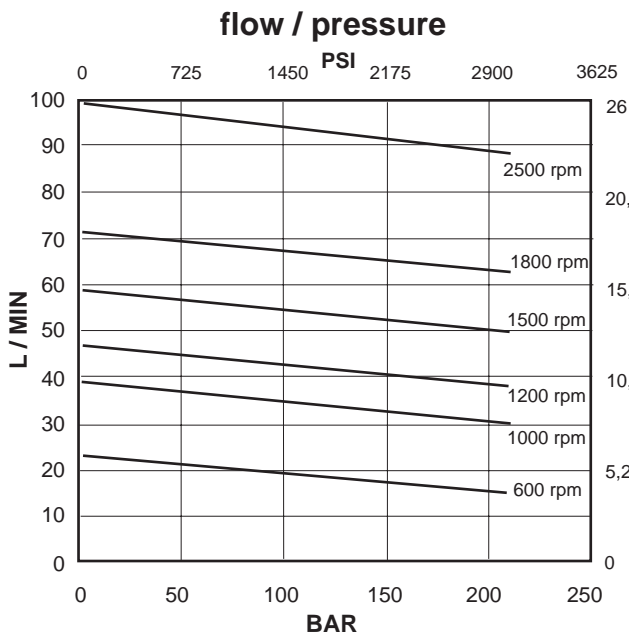

Oil viscosity: 25 c.St. (10W)
 Temperature: 45°C
 Inlet pressure: 0 BAR

Shaft end cartridge A02-14

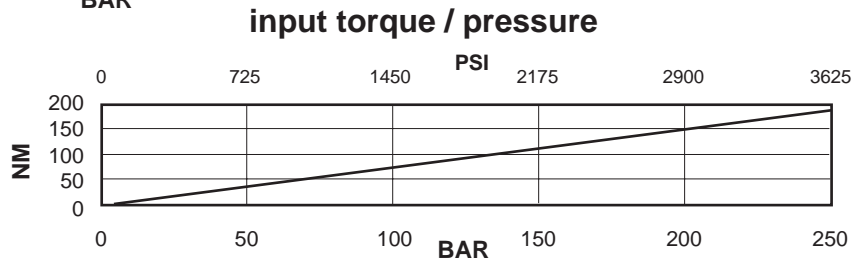
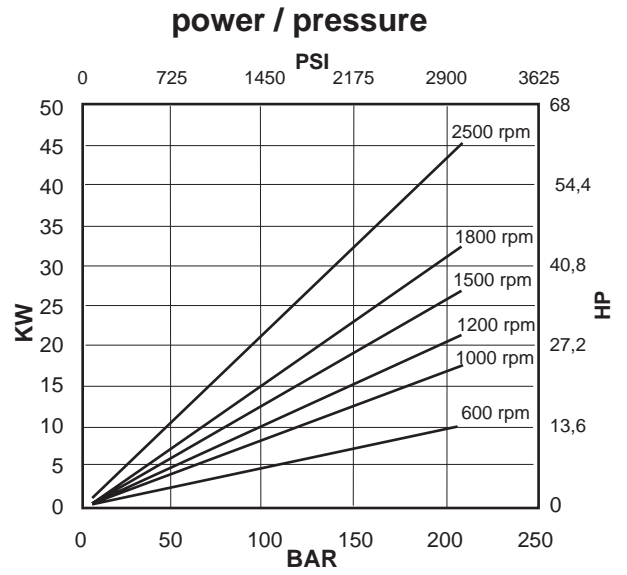
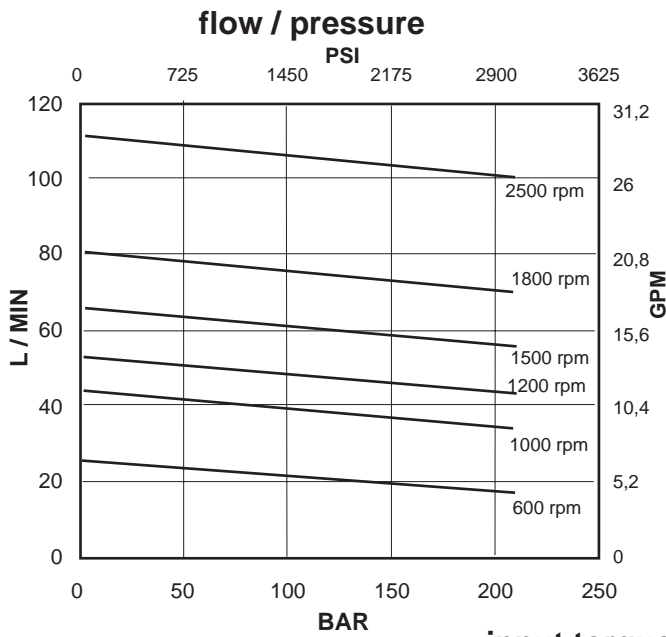

Oil viscosity: 25 c.St. (10W)
 Temperature: 45°C
 Inlet pressure: 0 BAR

Shaft end cartridge A02-17

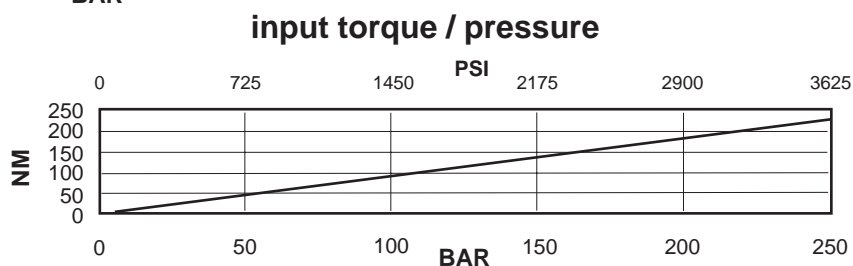
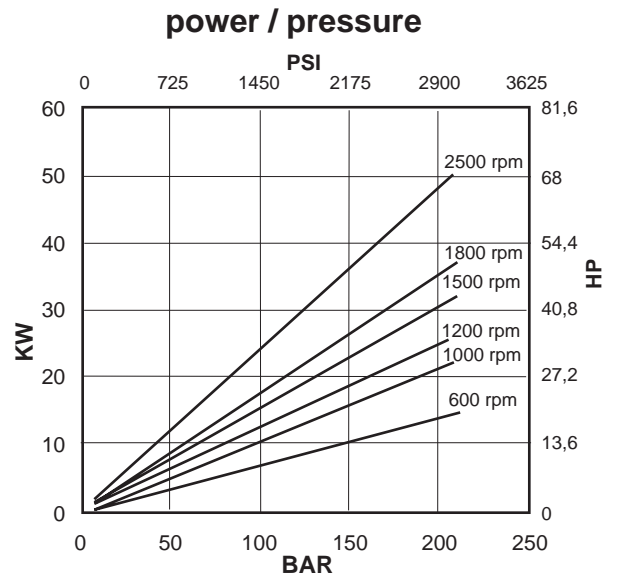
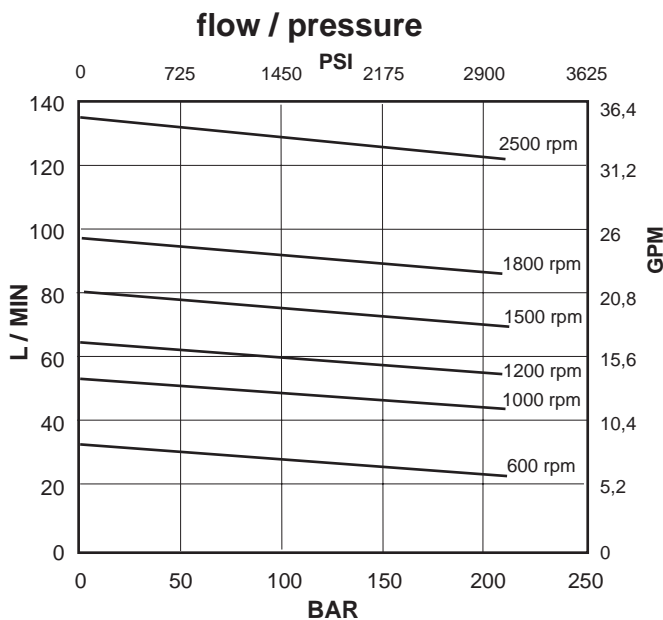

Oil viscosity: 25 c.St. (10W)
 Temperature: 45°C
 Inlet pressure: 0 BAR

Shaft end cartridge A02-19

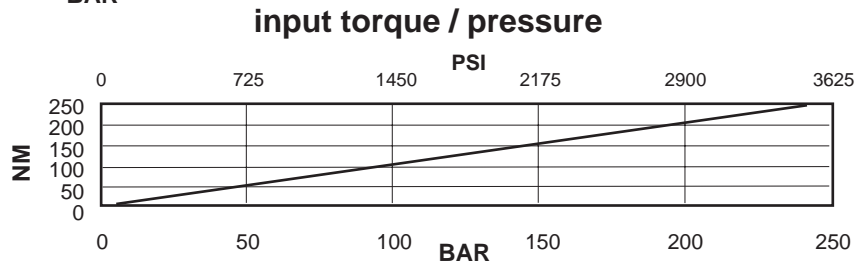
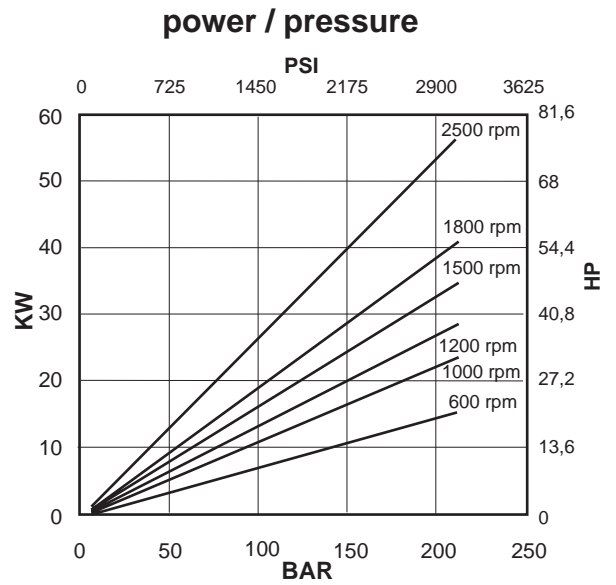
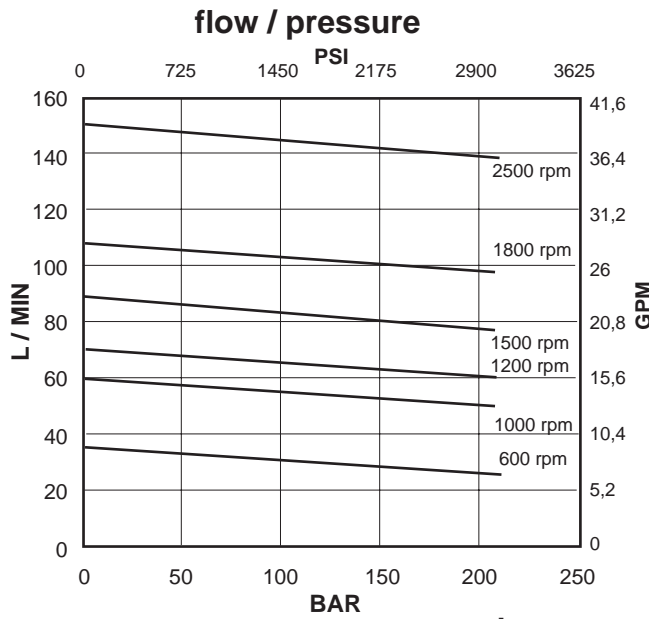

Oil viscosity: 25 c.St. (10W)
 Temperature: 45°C
 Inlet pressure: 0 BAR

Shaft end cartridge A02-21

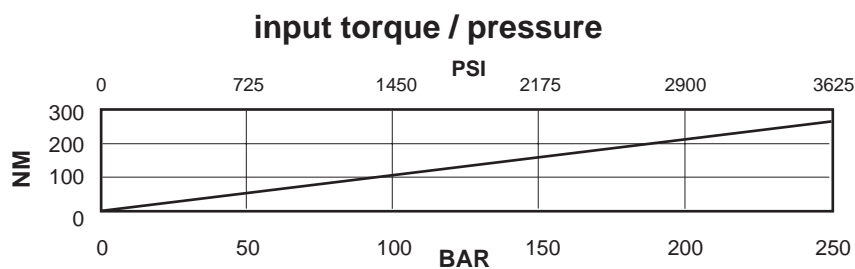
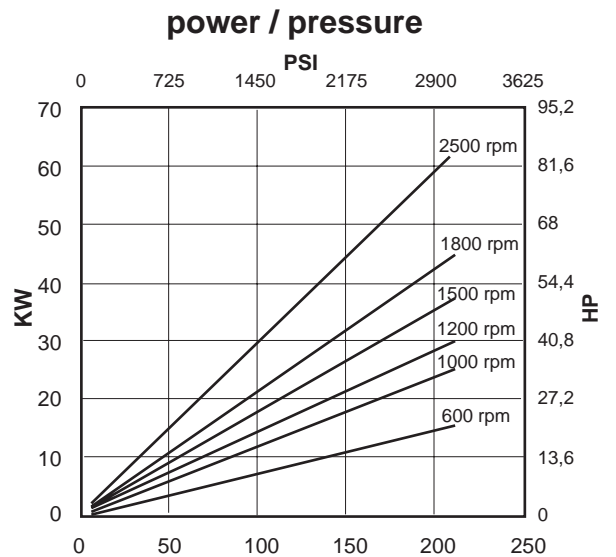
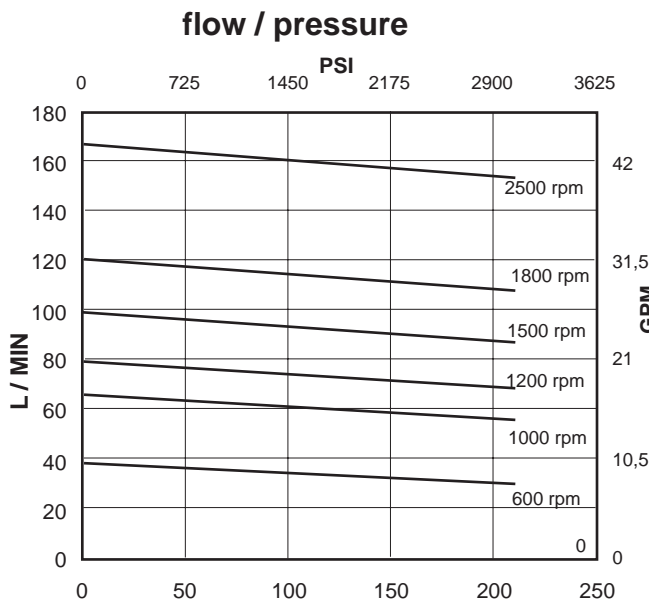

Oil viscosity: 25 c.St. (10W)
 Temperature: 45°C
 Inlet pressure: 0 BAR

flow / pressure

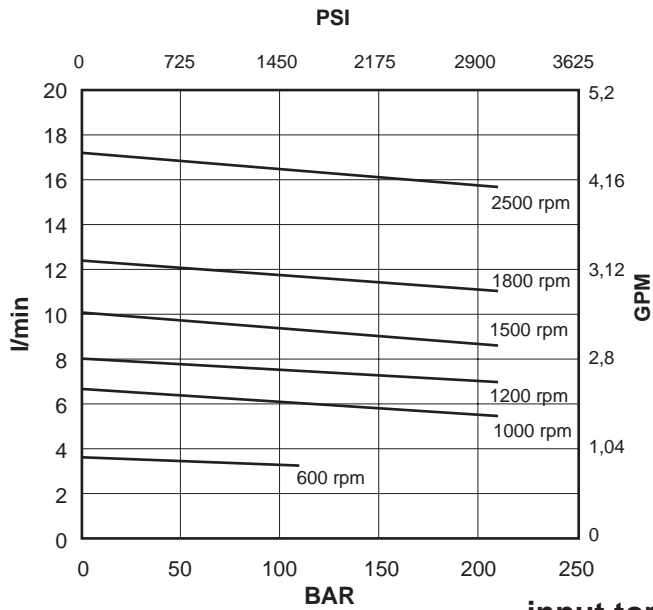

Cover end cartridge A01-02

power / pressure

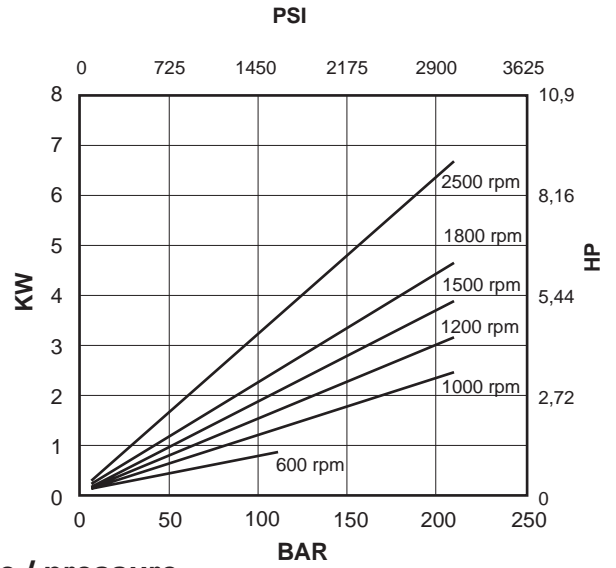

input torque / pressure

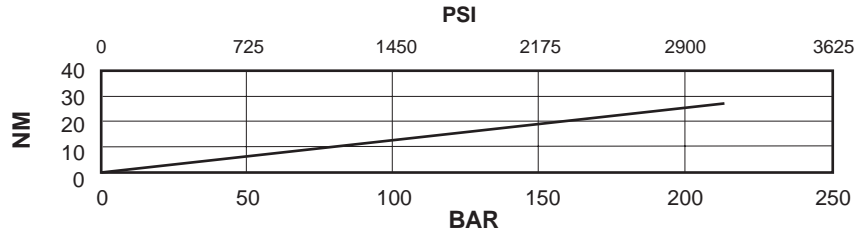

Oil viscosity: 25 c.St.(10W)
Temperature: 45°C
Inlet pressure: 0 BAR

flow / pressure

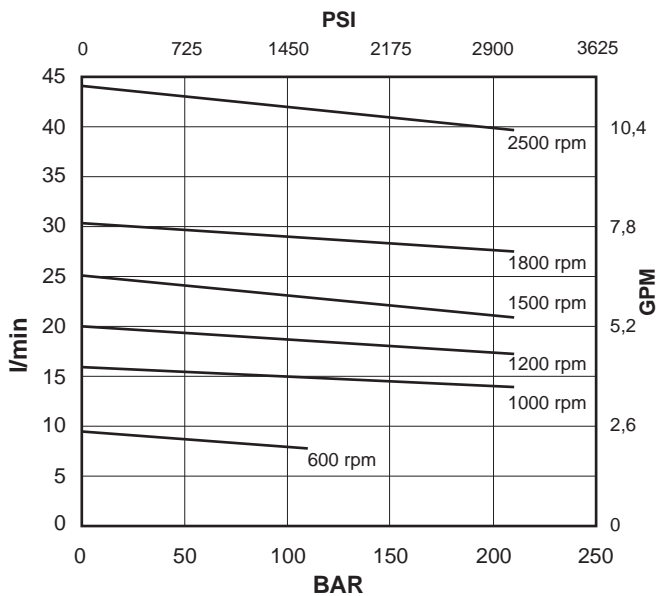

Cover end cartridge A01-05

power / pressure

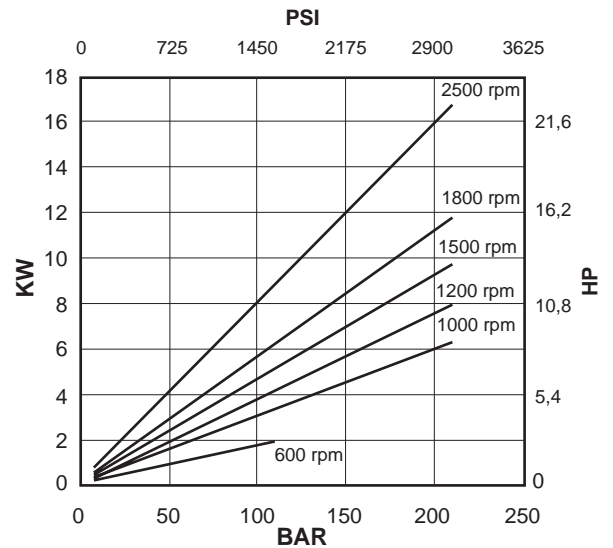

input torque / pressure

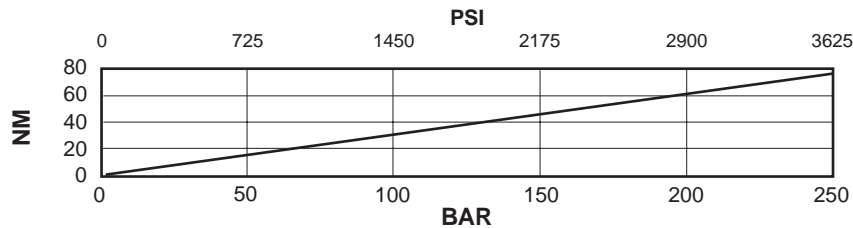

Oil viscosity: 25 c.St.(10W)
Temperature: 45°C
Inlet pressure: 0 BAR

Cover end cartridge A01-08

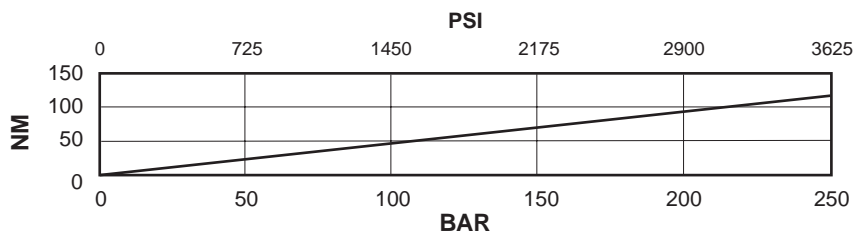
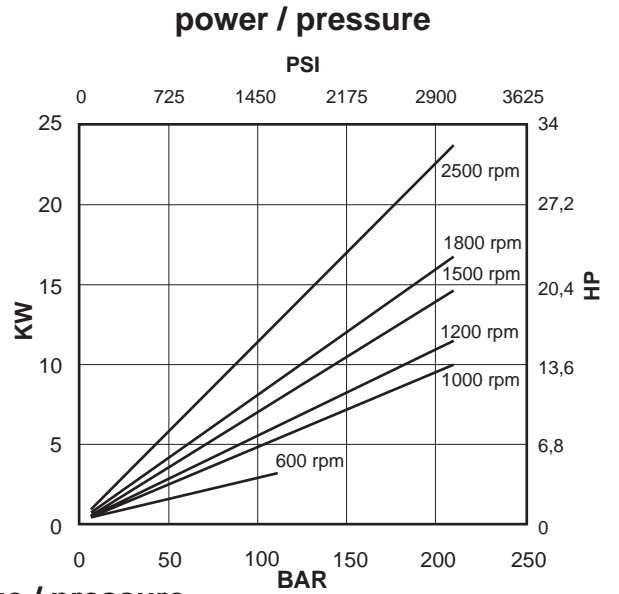
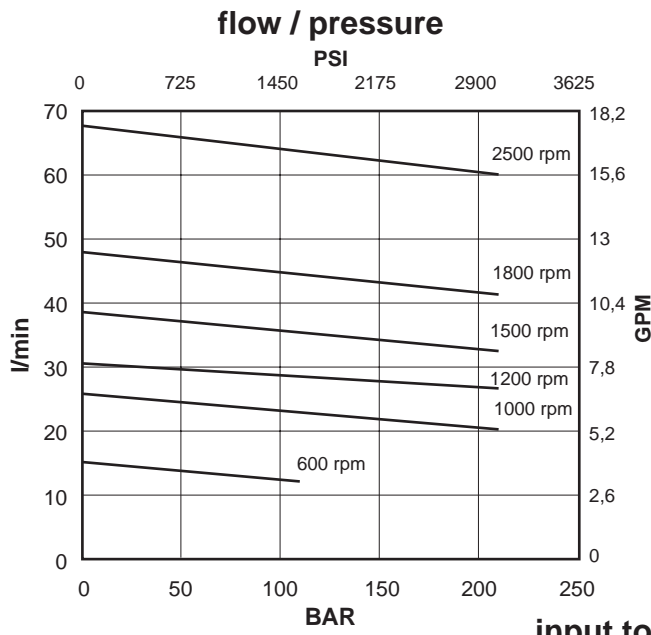

Oil viscosity: 25 c.St.(10W)
 Temperature: 45°C
 Inlet pressure: 0 BAR

Cover end cartridge A01-09

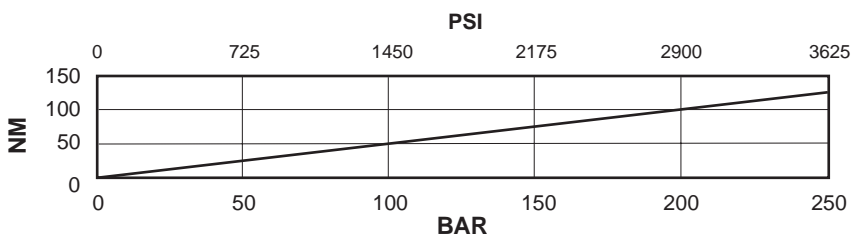
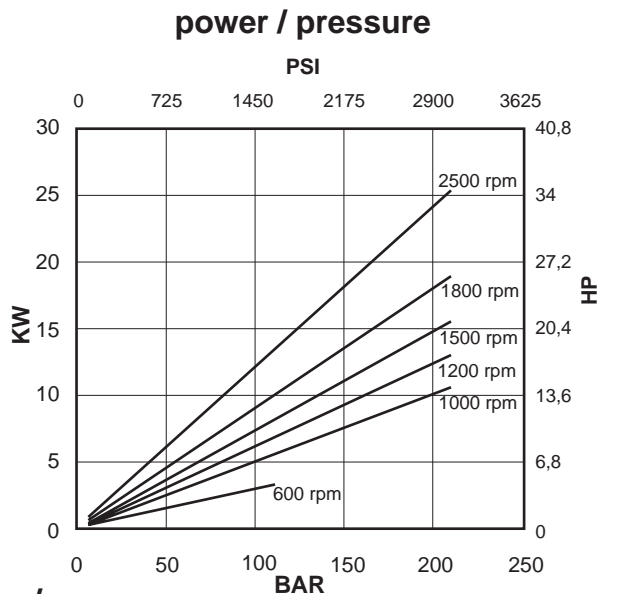
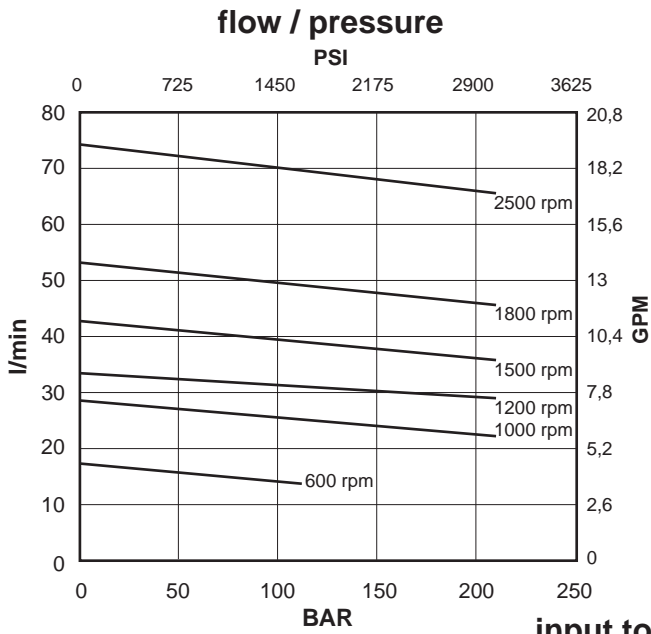

Oil viscosity: 25 c.St.(10W)
 Temperature: 45°C
 Inlet pressure: 0 BAR

Cover end cartridge A01-11

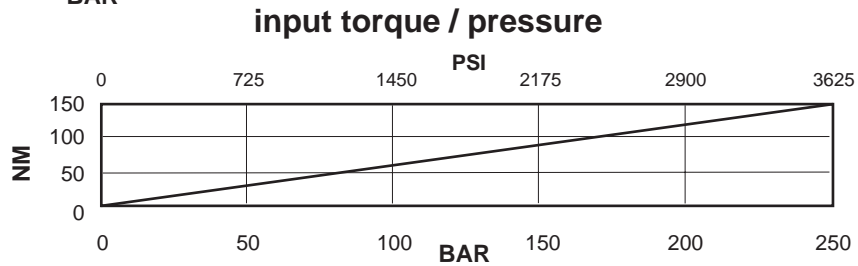
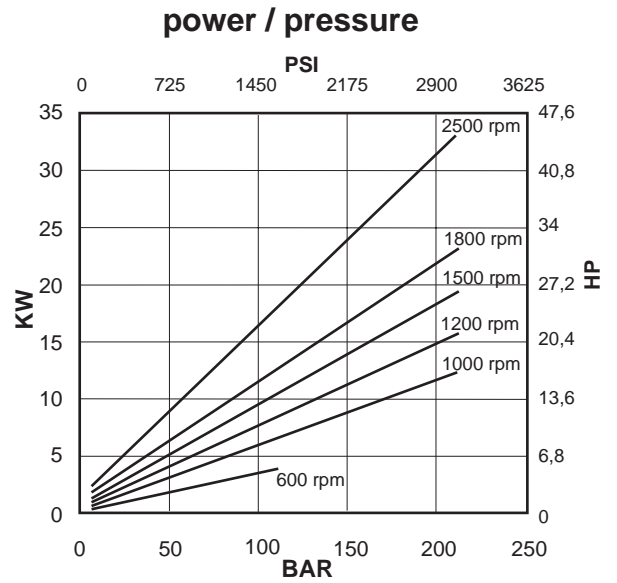
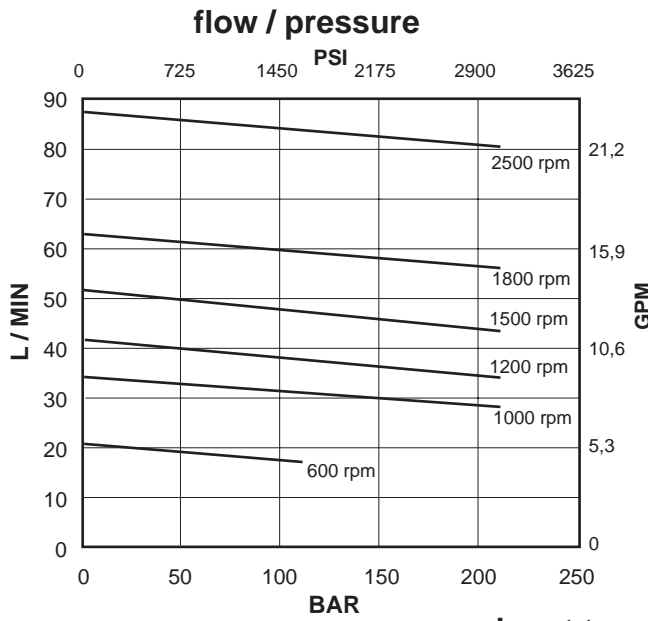

Oil viscosity: 25 c.St. (10W)
 Temperature: 45°C
 Inlet pressure: 0 BAR

Cover end cartridge A01-12

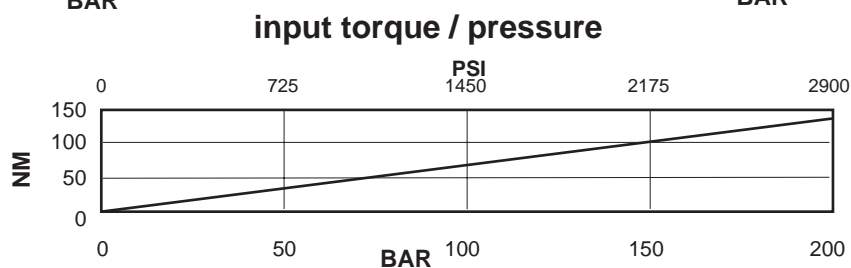
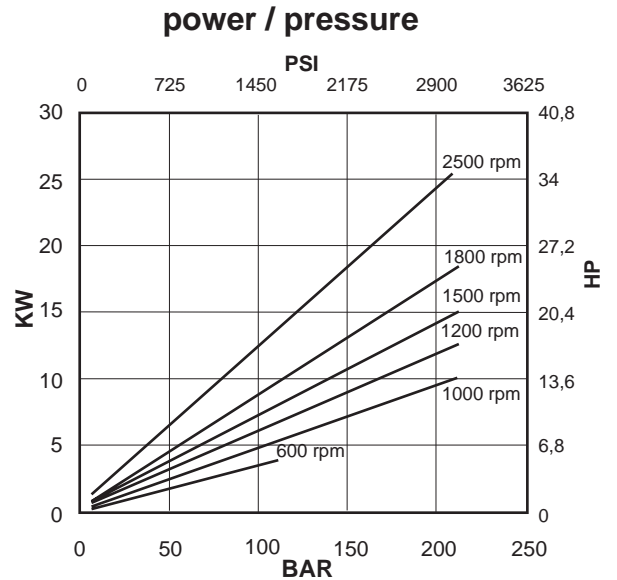
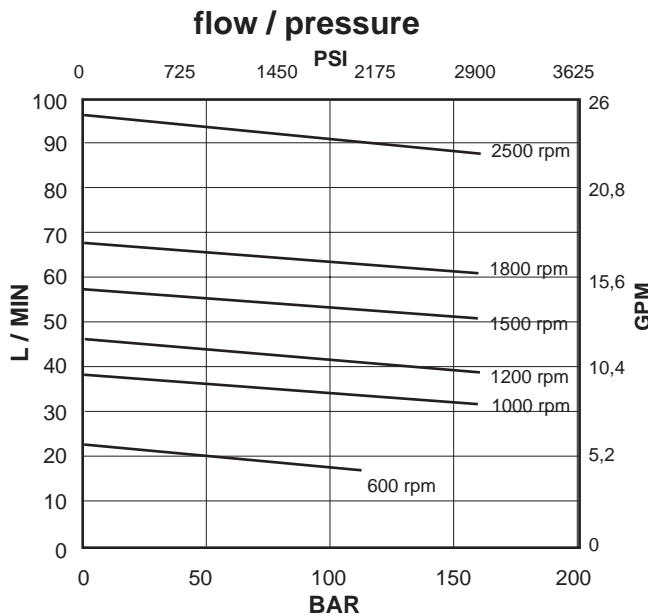

Oil viscosity: 25 c.St. (10W)
 Temperature: 45°C
 Inlet pressure: 0 BAR

Cover end cartridge A01-14

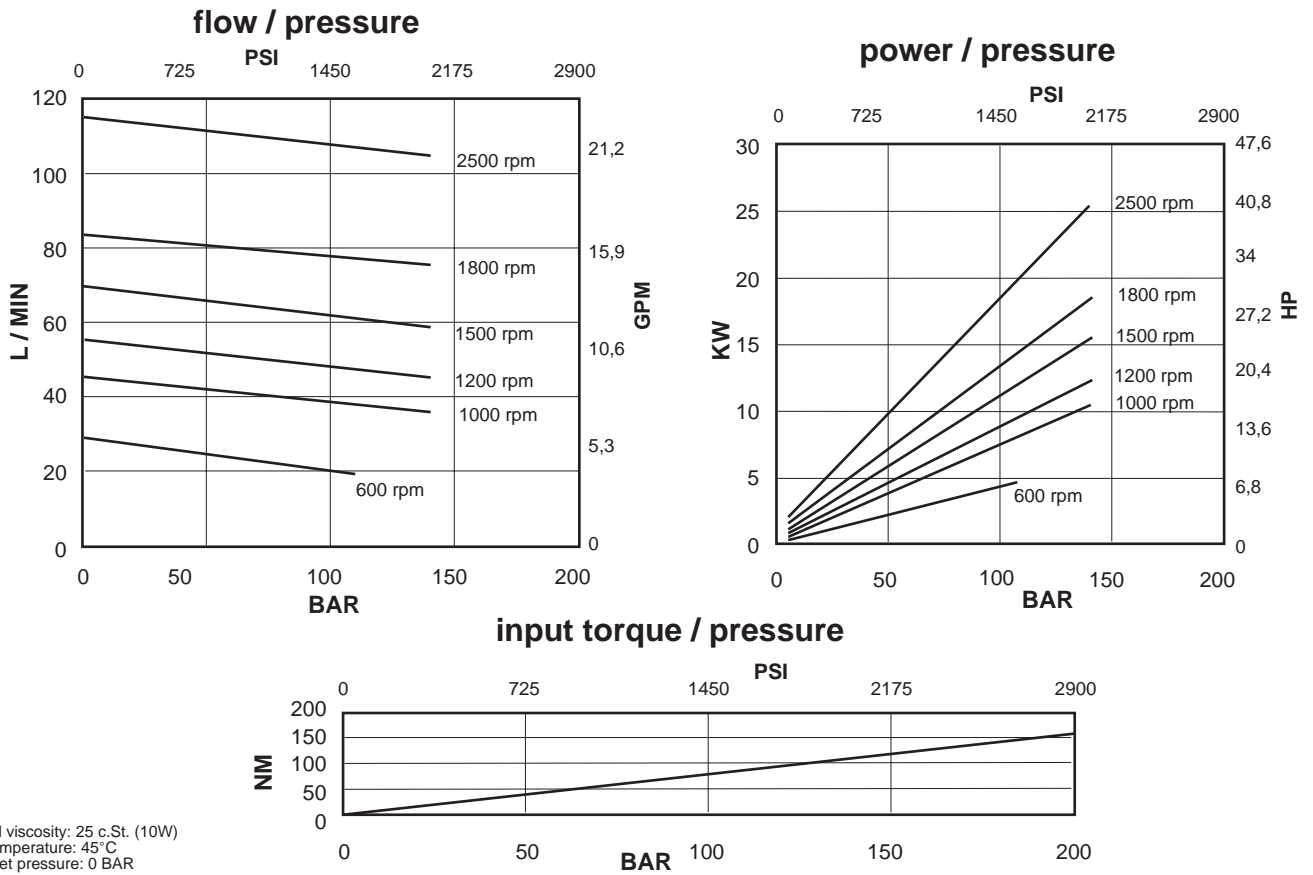

Installation dimensions mm (inches)

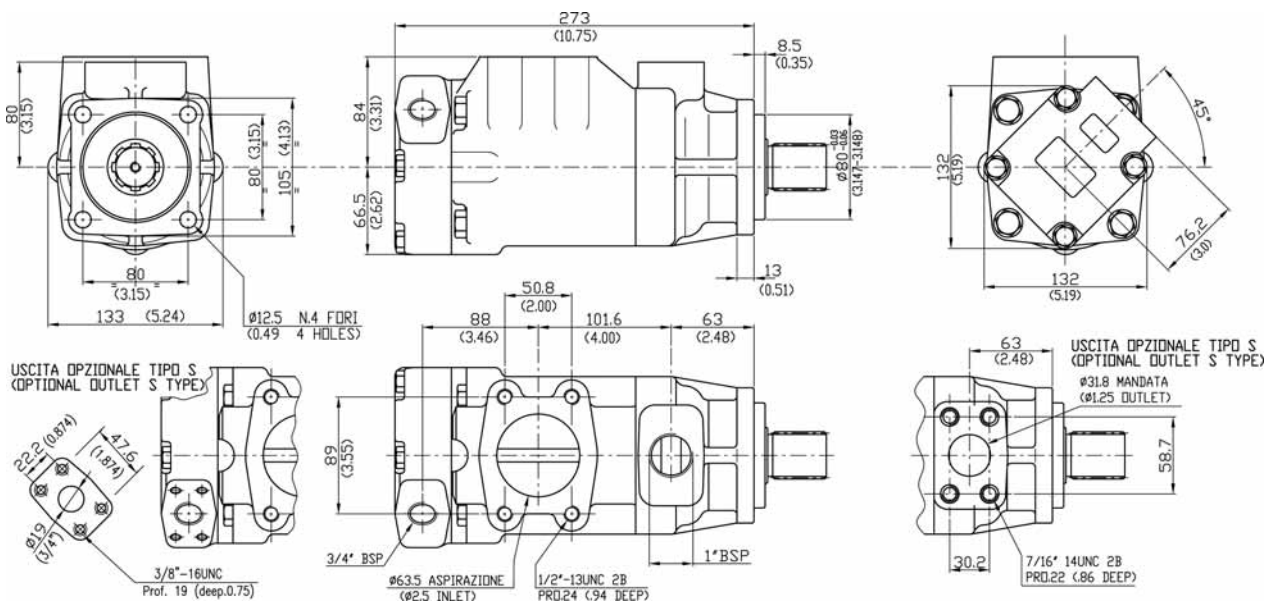

Approx. weight: 20,5 kg. (45 lbs.)

Model code breakdown

HQ 21 G * * * * * (L) (*)

Pump series

Design

Pump type

Cartridge types

- shaft end 12 14 17 19 21

- cover end 02 05 08 09 11 12 14

Body outlet port positions

(outlet viewed from cover end)

A = Outlet opposite end

B = Outlet 90° CCW from inlet

C = Outlet in line with inlet

D = Outlet 90° CW from inlet

Cover outlet port positions

(outlet viewed from cover end)

A = Outlet 135° CCW from inlet

B = Outlet 45° CCW from inlet

C = Outlet 45° CW from inlet

D = Outlet 135° CW from inlet

Seals

(omit with standard seals and shaft-seals in NBR)

V = seals and shaft-seals in FPM (Viton®)

Rotation

(viewed from shaft end)

L = left hand rotation CCW

(omit if CW)

Outlet port connection

(omit if GAS threaded)

S = SAE port with 4 holes connection

Shaft end

50 = Splined shaft with ISO 14 four holes flange

Shaft mm (inches)

Shaft
50

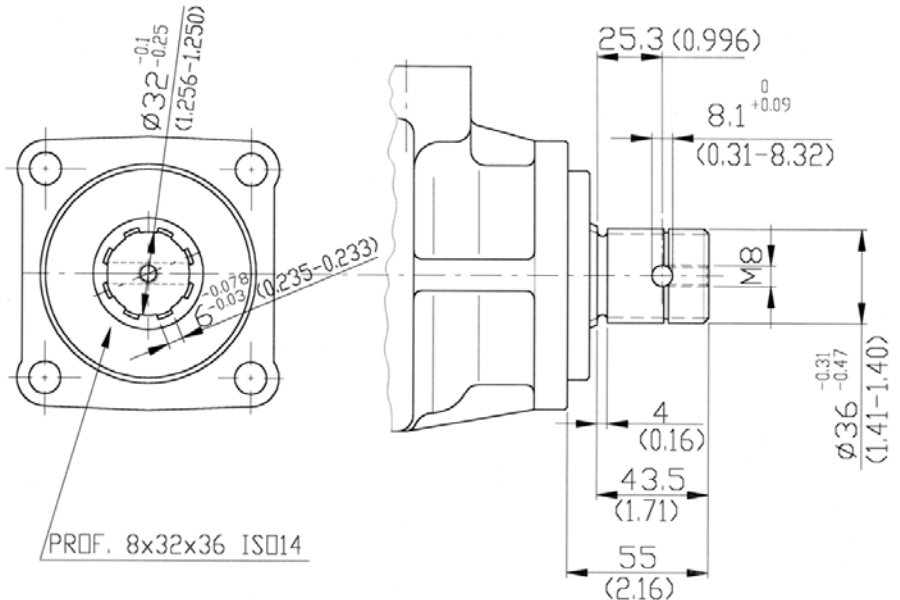

PORT ORIENTATIONS

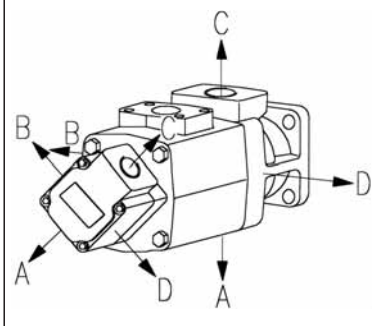

Id. codes of pump components

Cartridges				Pump rotation	
Cover end		Shaft end			
Series	Model	Part No.	Series	Model	Part No.
A01	02	A0102000	A02	12	A0212030
	05	A0105010		14	A0214070
	08	A0108030		17	A0217110
	09	A0109050		19	A0219150
	11	A0111070		21	A0221190
	12	A0112090			
	14	A0114110			
A01	02	A0102005	A02	12	A0212040
	05	A0105020		14	A0214080
	08	A0108040		17	A0217120
	09	A0109060		19	A0219160
	11	A0111080		21	A0221200
	12	A0112100			
	14	A0114120			

Body	
Model	PART NO.
STD	M8020016
S	M8020017

Shaft	
Model	PART NO.
50	K2150000

Seeger	
PART NO.	M6000010

Shaft kit	
Model	PART NO.
50	M6215000

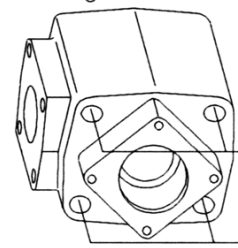
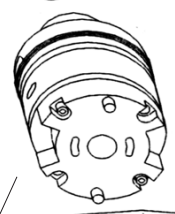
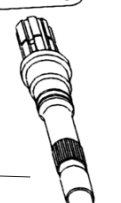
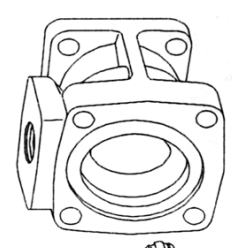

Shaft seal	
PART NO.	Type
M8020060	NBR
M8020065	FPM

Bearing	
PART NO.	M8020030

Seeger	
PART NO.	M8020050

Inlet body	
PART NO.	M8020110

Cover	
Model	PART NO.
STD	M8020121
S	M8020120

Seeger	
PART NO.	M8020040

Screw	
PART NO.	M8020130
Torque to 102 Nm (910 lb. in.)	

Screw	
PART NO.	M8020420
Torque to 70 Nm (624 lb. in.)	

Pump seal kit		
PART NO.	Parts	Type
M6215500	seals + 2 shaft seals	NBR
M6215510	seals + 2 shaft seals	FPM (Viton®)

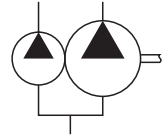
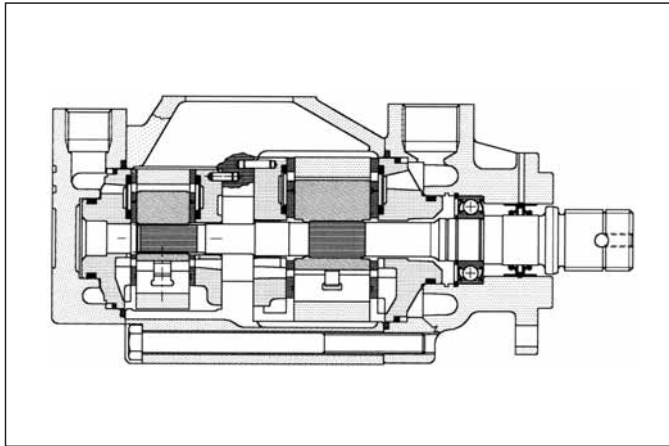

General description

Fixed displacement vane pump, hydraulically balanced, with capacity determined by the type of cartridge used and the speed of rotation. The pump is available in several versions with rated capacities from 82 to 134 l/min (from 22 to 35 gpm) at 1000 rpm and 7 bar.

Technical characteristics

Cartridge model	Geometric displacement		Rated capacity at 1000 rpm 7 bar		Rated capacity at 1200 rpm 7 bar		Rated capacity at 1500 rpm 7 bar		Maximum pressure with mineral oil		Speed range rpm	
	cm ³ /g	(in ³ /r)	l/min	(gpm)	l/min	(gpm)	l/min	(gpm)	bar	(psi)	min	max
shaft end												
A03-24	78,3	(4.78)	75,0	(20.0)	90	(24)	115,3	(30.5)	210	(3050)	600	2500
A03-28	91,2	(5.56)	88,3	(23.3)	106	(28)	131,8	(34.8)	210	(3050)	600	2500
cover end												
A01-02	7,2	(0.44)	6,9	(1.7)	8,3	(2)	10,4	(2.8)	210	(3050)	600	2700
A01-05	18,1	(1.10)	17,3	(4.2)	20,8	(5)	26,1	(6.9)	210	(3050)	600	2700
A01-08	27,4	(1.67)	26,5	(6.7)	31,8	(8)	39,4	(10.4)	210	(3050)	600	2700
A01-09	30,1	(1.83)	29,2	(7.5)	35,1	(9)	44,1	(11.7)	210	(3050)	600	2700
A01-11	36,4	(2.22)	35,3	(9.2)	42,4	(11)	52,6	(13.9)	210	(3050)	600	2700
A01-12	39,5	(2.41)	39,1	(10.0)	46,9	(12)	58,7	(15.5)	160	(2300)	600	2700
A01-14	45,9	(2.79)	45,8	(11.7)	54,9	(14)	69,6	(18.4)	140	(2030)	600	2700

Hydraulic fluids: mineral oils, phosphate ester based fluids.

Viscosity range (with mineral oil): from 13 to 860 cSt. (13 to 54 cSt. recommended).

Filtration: for the inlet - 149 micron abs., for the return line - 25 micron abs. or better (with synthetic fluids: for the return line - 10 micron abs. or better).

Inlet pressure (with mineral oil): from -0,17 to +0,35 bar (-2.5 + 5 psi)

Operating temperature: with mineral oil -10°C to +70°C (+30°C to +60°C recommended).

Drive: direct and coaxial by means of a flexible coupling.

Main operating data

max pressure / hydraulic fluid

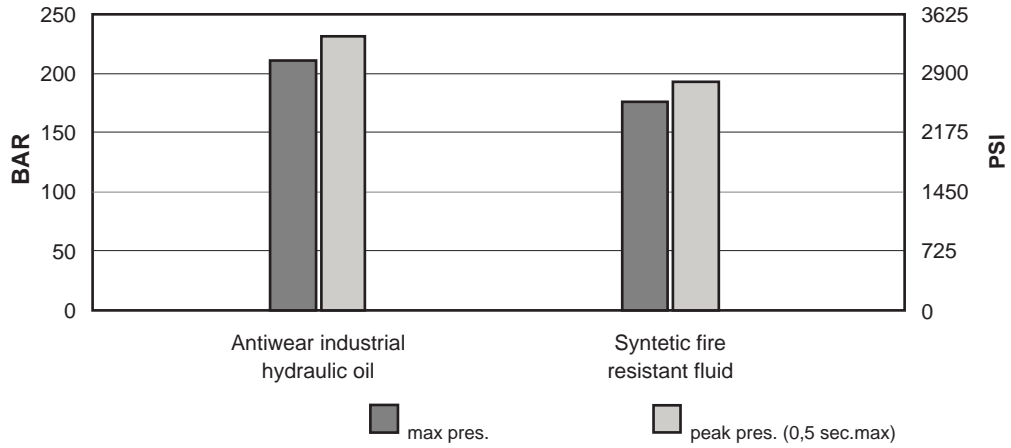

max speed / hydraulic fluid (with 0 bar in the intake pipe)

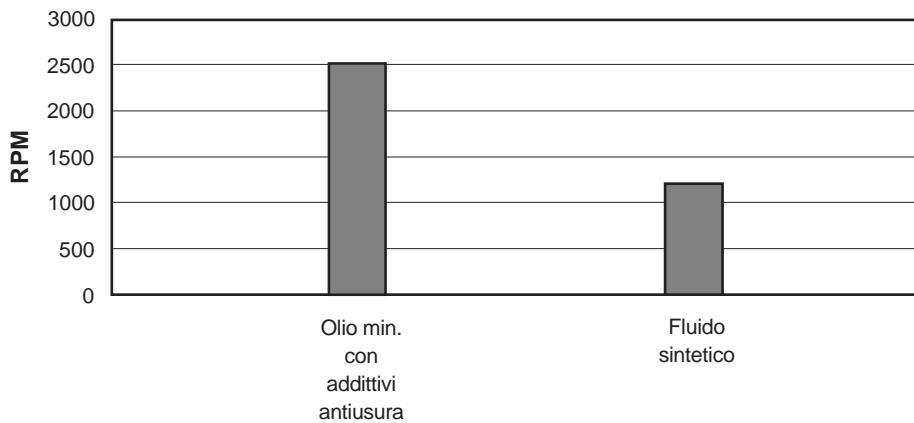

If the intake pressure is not zero bar, use the graph below to find the percentage correction factor to apply to the maximum speed.

max speed / intake pipe pressure

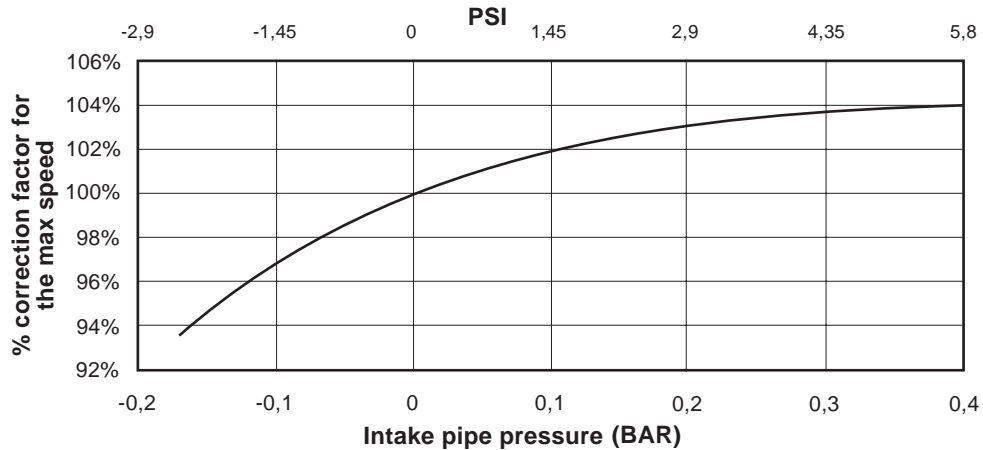

Shaft end cartridge A03-24

flow / pressure

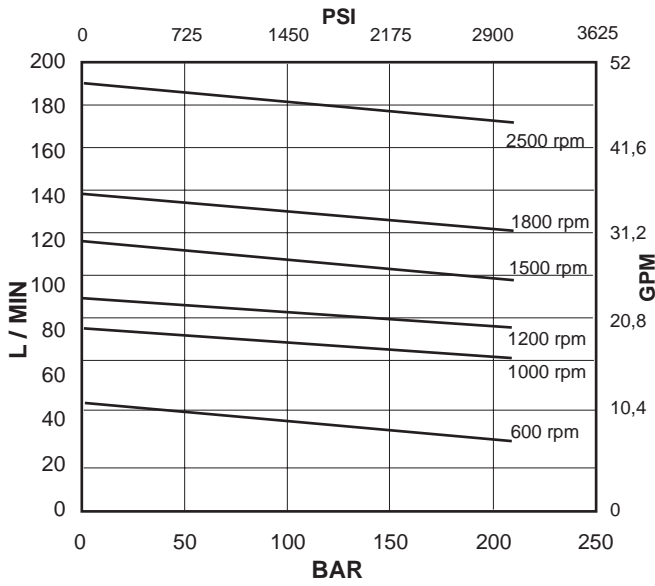

power / pressure

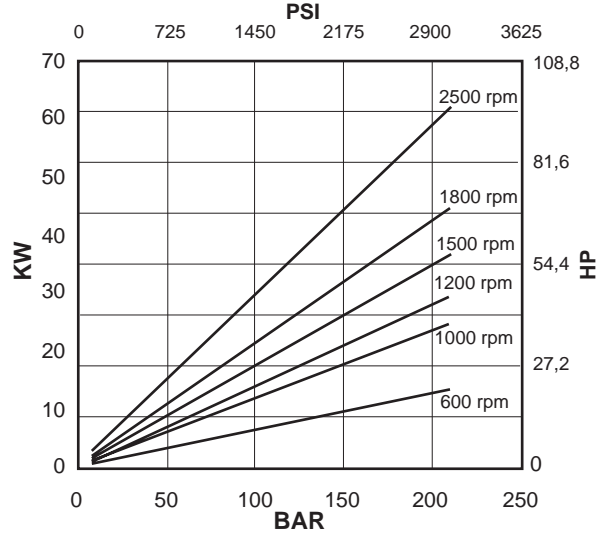

input torque / pressure

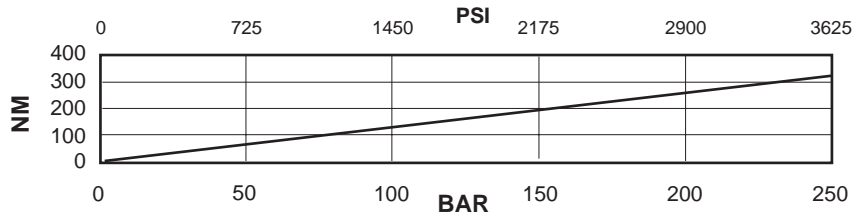

Oil viscosity: 25 c.St. (10W)
Temperature: 45°C
Inlet pressure: 0 BAR

Shaft end cartridge A03-28

flow / pressure

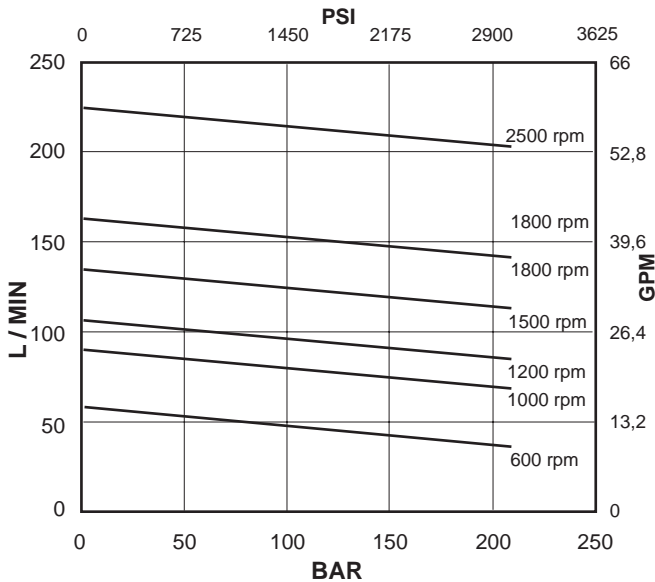

power / pressure

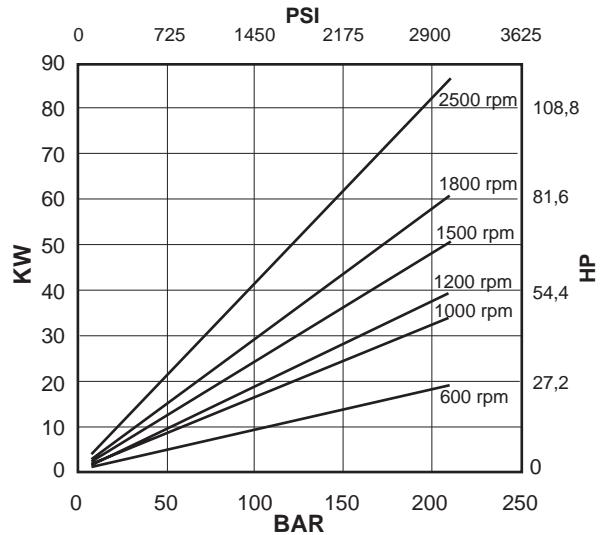

input torque / pressure

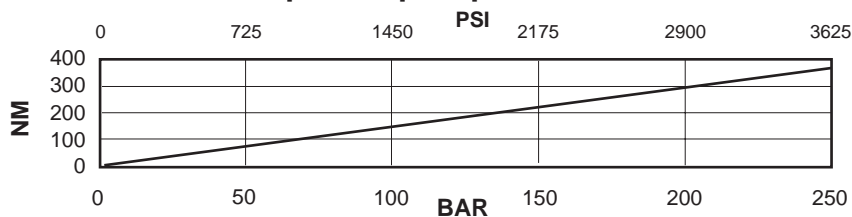

Oil viscosity: 25 c.St. (10W)
Temperature: 45°C
Inlet pressure: 0 BAR

Cover end cartridge A01-02

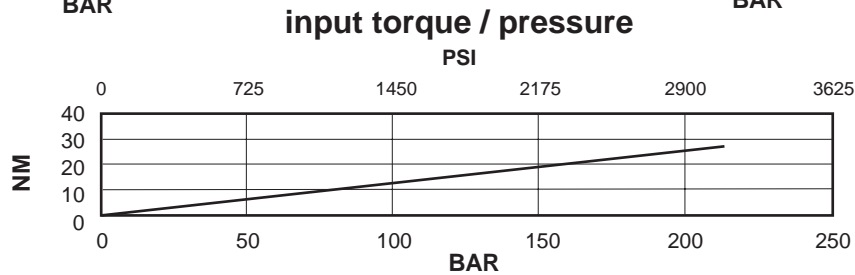
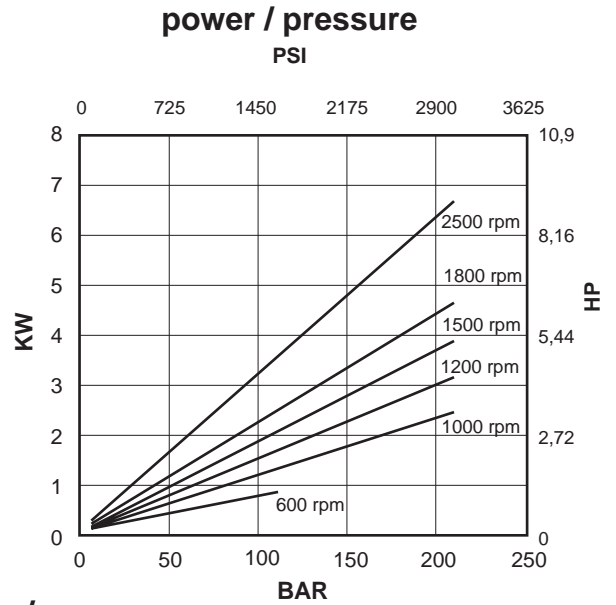
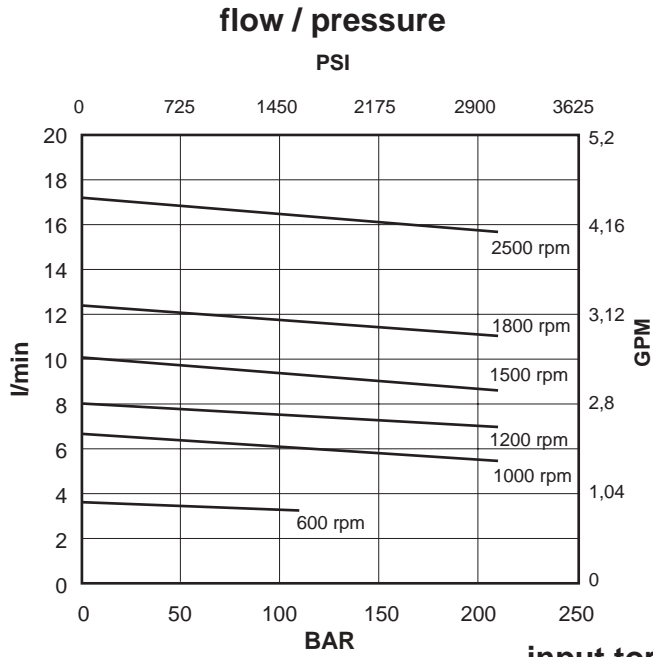

Oil viscosity: 25 c.St.(10W)
 Temperature: 45°C
 Inlet pressure: 0 BAR

Cover end cartridge A01-05

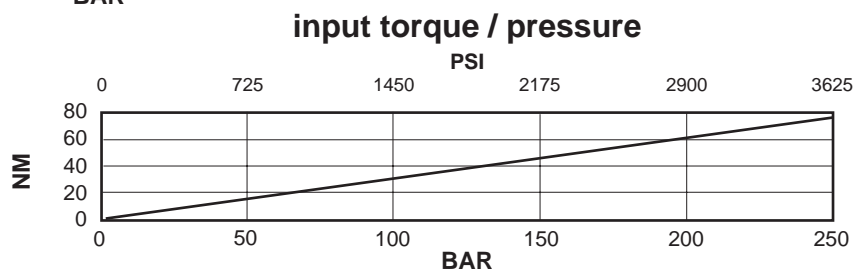
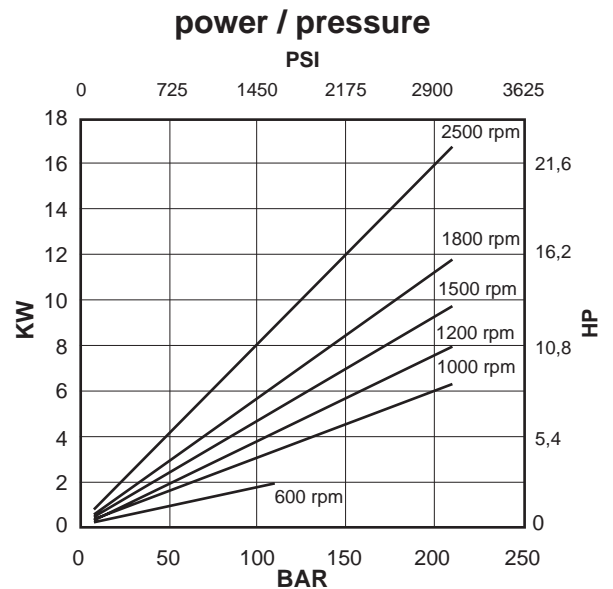
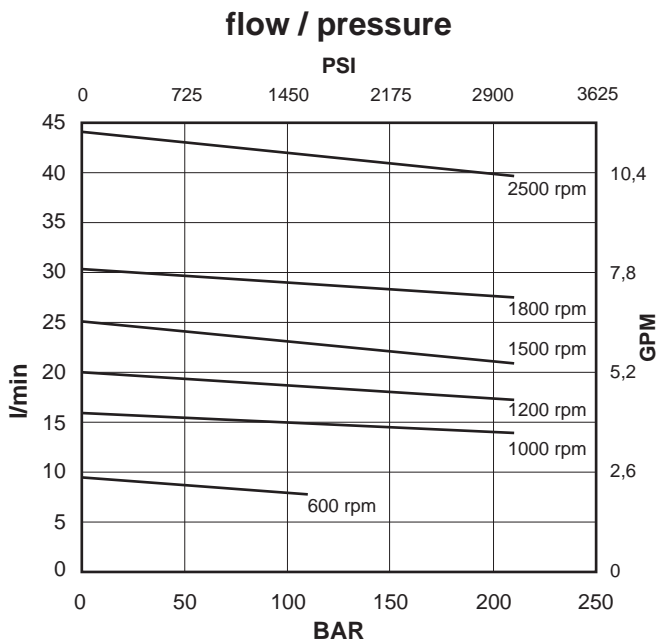

Oil viscosity: 25 c.St.(10W)
 Temperature: 45°C
 Inlet pressure: 0 BAR

Cover end cartridge A01-08

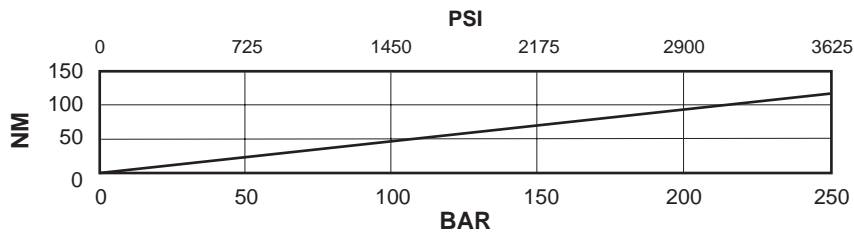
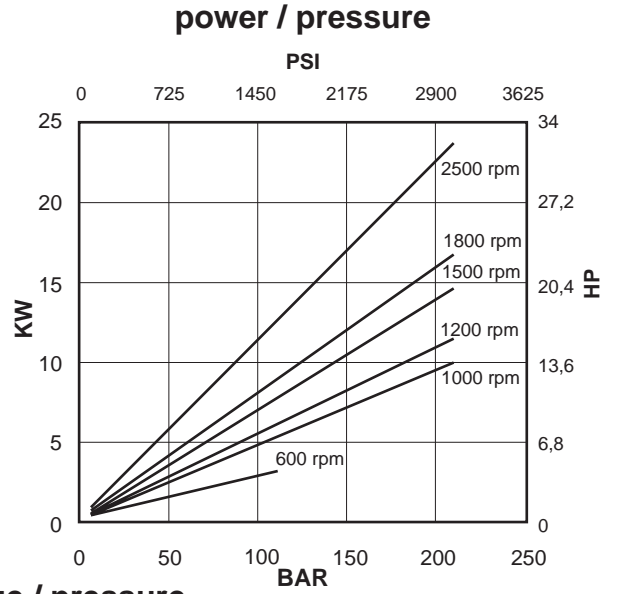
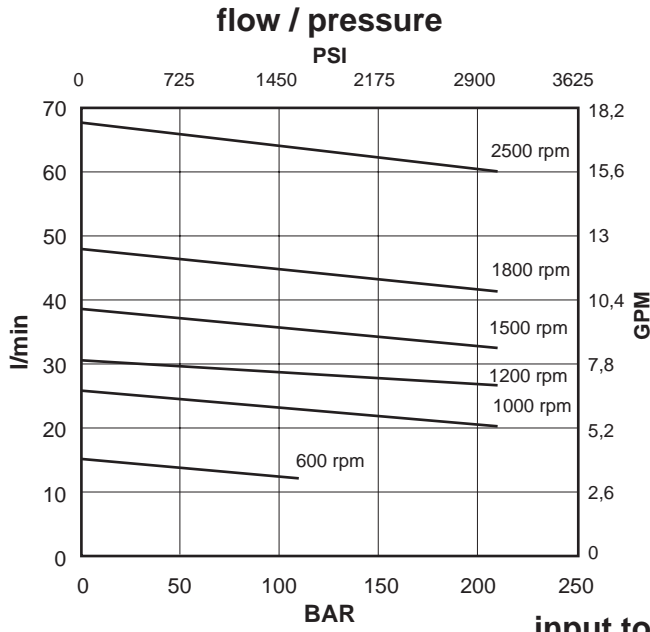

Oil viscosity: 25 c.St.(10W)
Temperature: 45°C
Inlet pressure: 0 BAR

Cover end cartridge A01-09

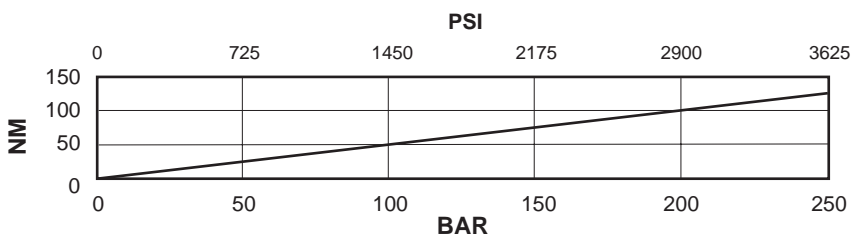
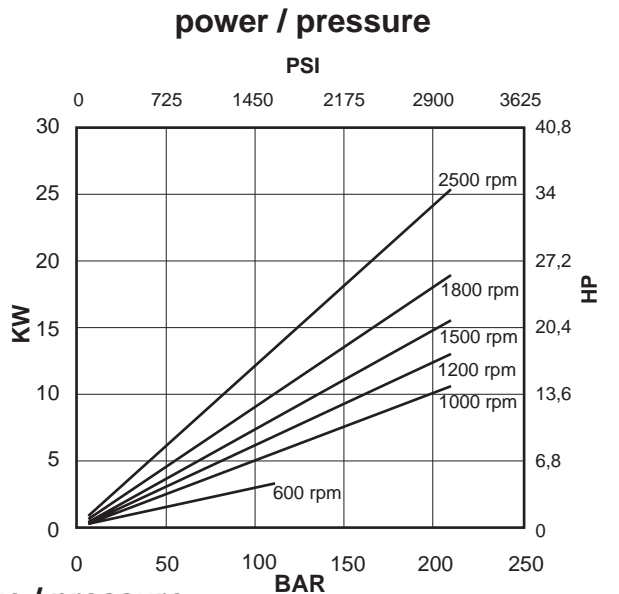
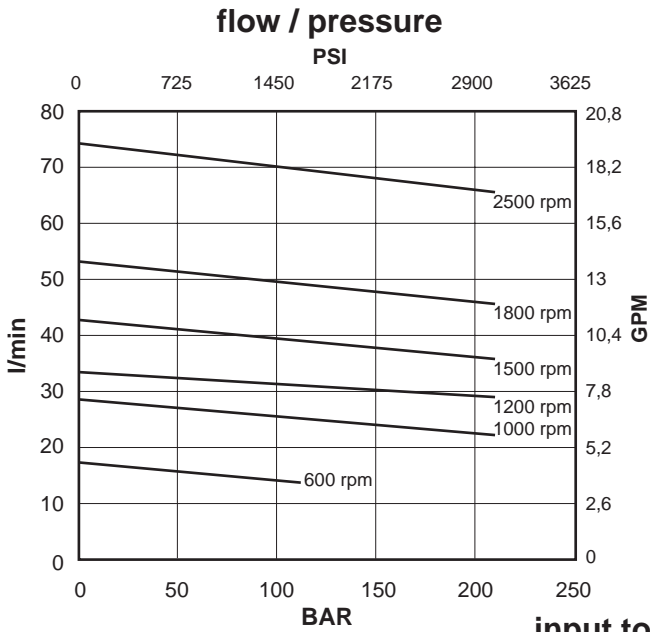

Oil viscosity: 25 c.St.(10W)
Temperature: 45°C
Inlet pressure: 0 BAR

Cover end cartridge A01-11

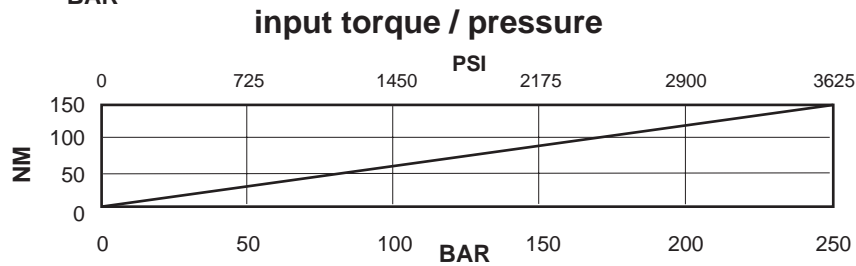
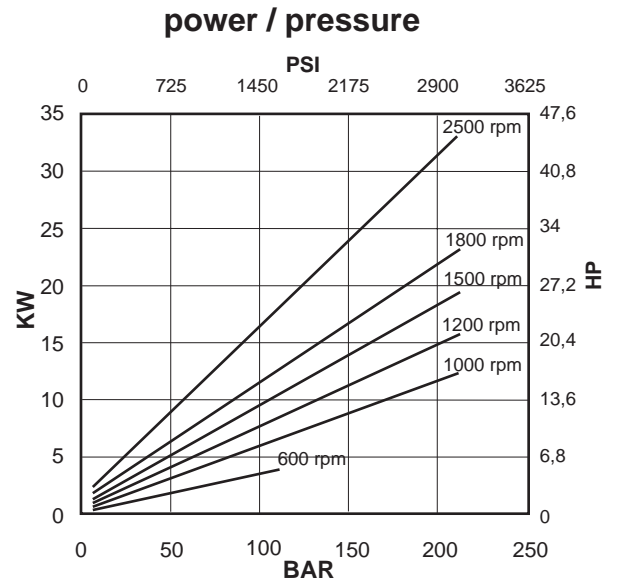
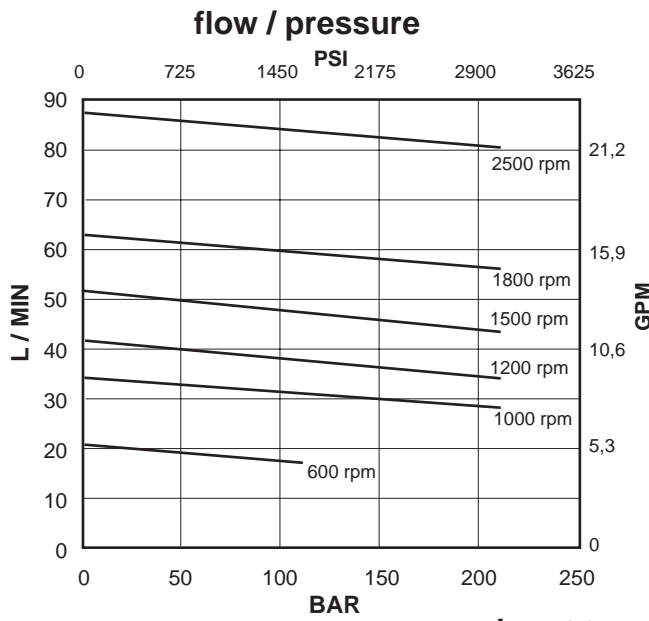

Oil viscosity: 25 c.St. (10W)
 Temperature: 45°C
 Inlet pressure: 0 BAR

Cover end cartridge A01-12

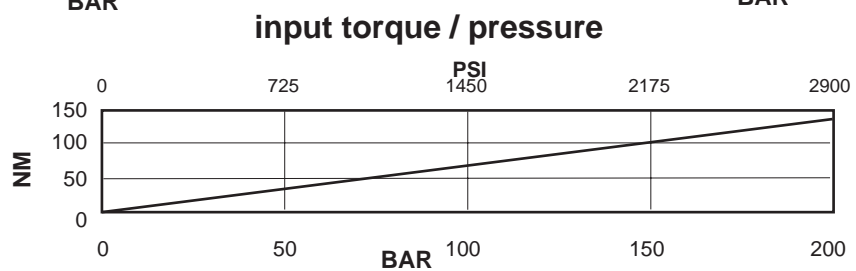
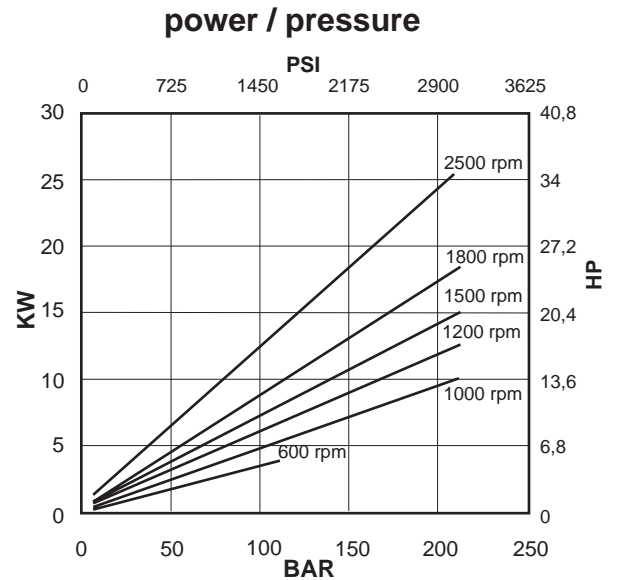
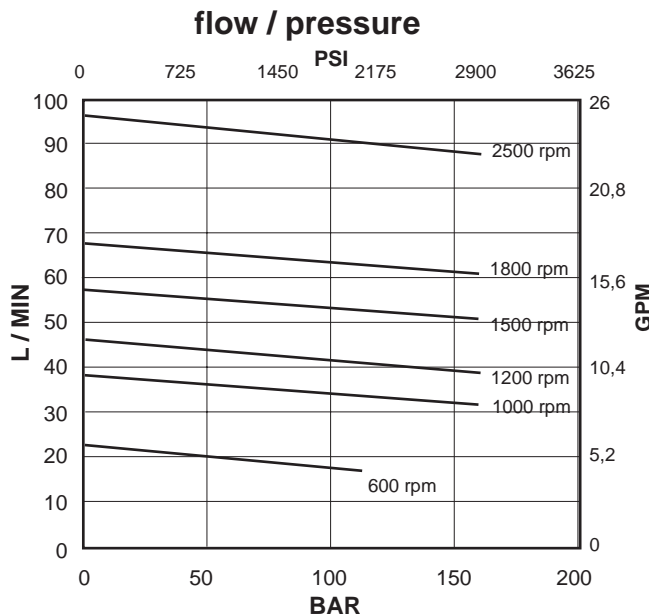

Oil viscosity: 25 c.St. (10W)
 Temperature: 45°C
 Inlet pressure: 0 BAR

Cover end cartridge A01-14

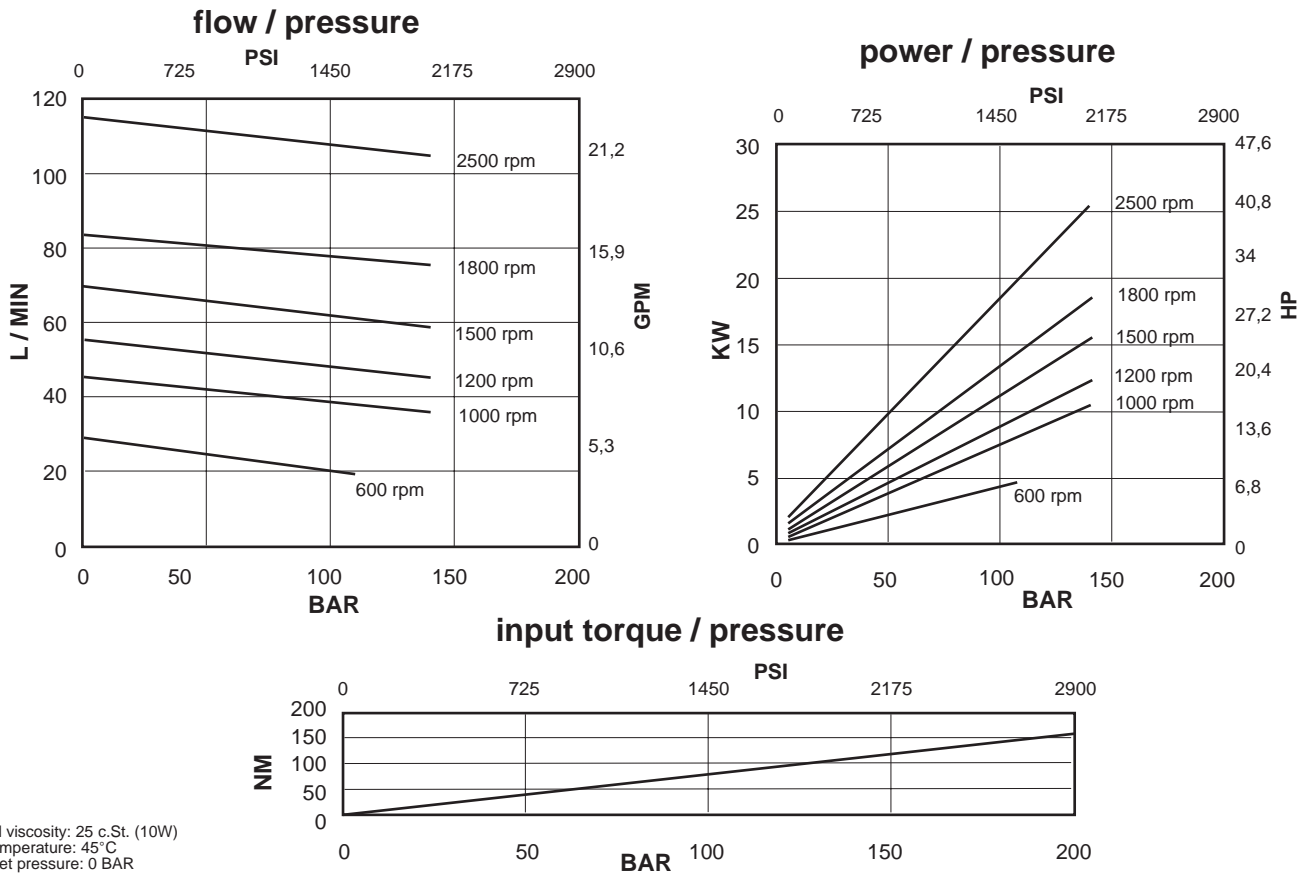

Installation dimensions mm (inches)

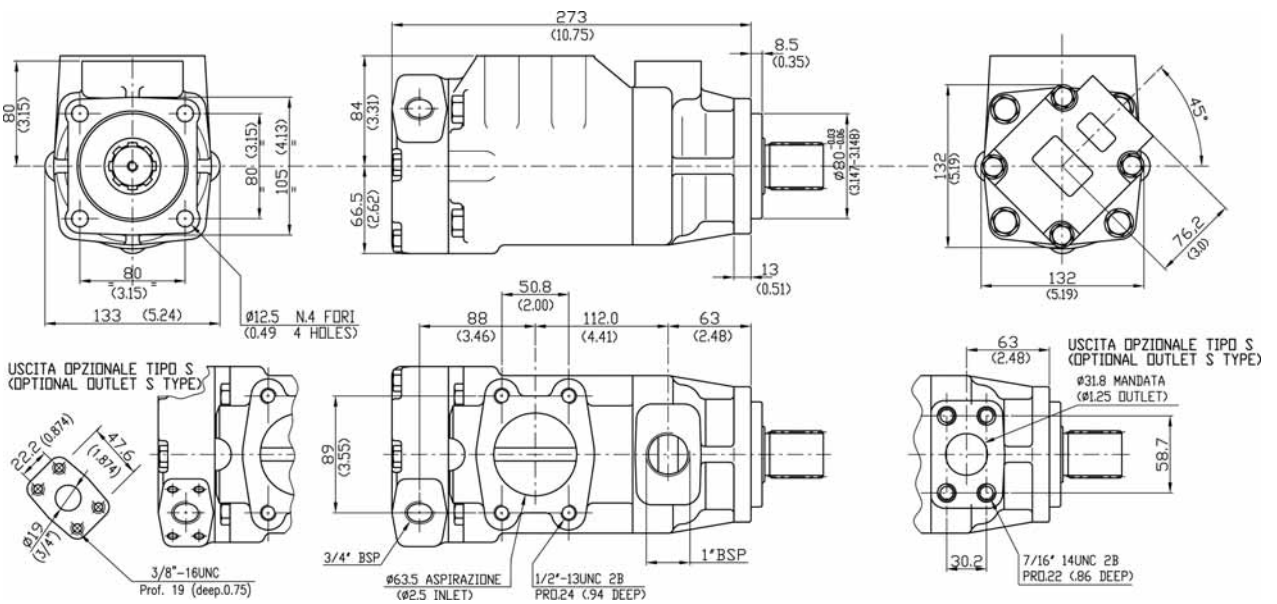

Approx. weight: 22,7 kg. (50 lbs.)

Model code breakdown

HQ 31 G * * * * * (L) (*)

Pump series

Design

Pump type

Cartridge types

- shaft end 24 28

- cover end 02 05 08 09 11 12 14

Body outlet port positions

(outlet viewed from cover end)

A = Outlet opposite end

B = Outlet 90° CCW from inlet

C = Outlet in line with inlet

D = Outlet 90° CW from inlet

Cover outlet port positions

(outlet viewed from cover end)

A = Outlet 135° CCW from inlet

B = Outlet 45° CCW from inlet

C = Outlet 45° CW from inlet

D = Outlet 135° CW from inlet

Seals

((mit with standard seals and shaft-seals in NBR)

V = seals and shaft-seals in FPM (Viton®)

Rotation

(viewed from shaft end)

L = left hand rotation CCW

(omit if CW)

Outlet port connection

(omit if GAS threaded)

S = SAE port with 4 holes connection

Shaft end

50 = Splined shaft with ISO 14 four holes flange

Shaft mm (inches)

Shaft
50

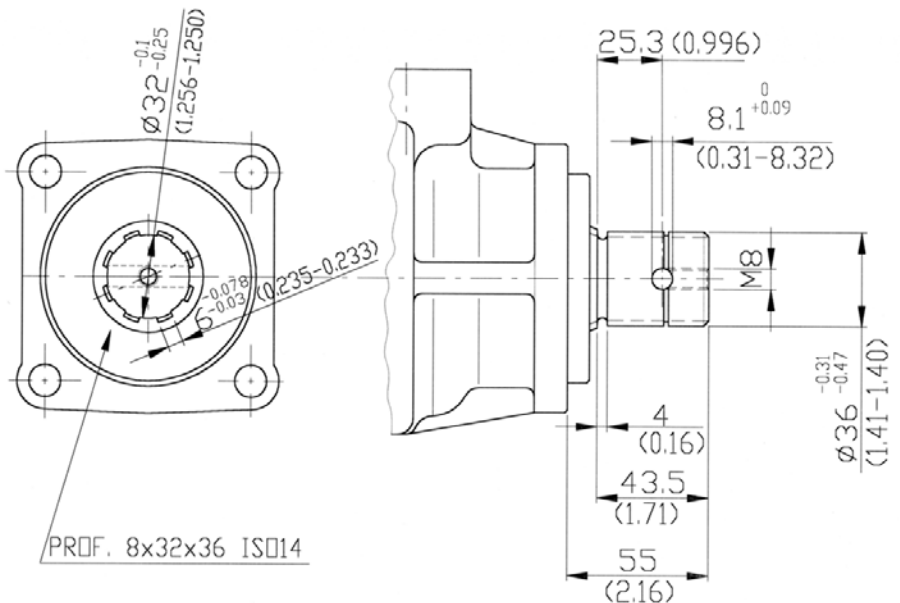

PORT ORIENTATIONS

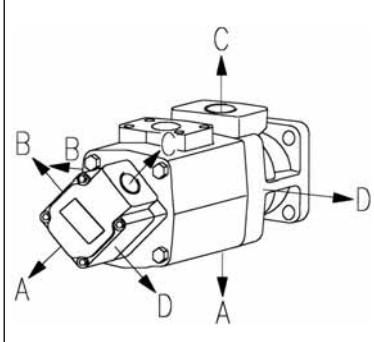



Id. codes of pump components

Cartridges				Pump rotation				
Cover end		Shaft end						
Series	Model	Part No.	Series	Model	Part No.			
A01	02	A0102000	A03	24	A0324030			
	05	A0105010		28	A0328070			
	08	A0108030	right hand					
	09	A0109050						
	11	A0111070						
	12	A0112090						
14	A0114110	left hand						
A01	02				A0102005	A03	24	A0324040
	05				A0105020		28	A0328080
	08				A0108040			
	09	A0109060						
	11	A0111080						
	12	A0112100						
14	A0114120							

Seeger	
PART NO.	M6000010

Shaft kit	
Model	50
PART NO.	M6315000

Shaft	
Model	50
PART NO.	K3150000

Body	
Model	STD
PART NO.	M8020016
	S
PART NO.	M8020017

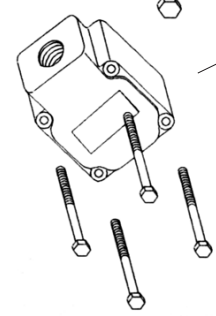
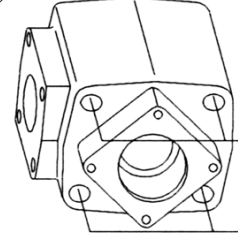
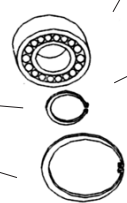
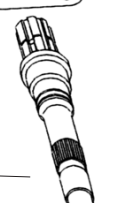
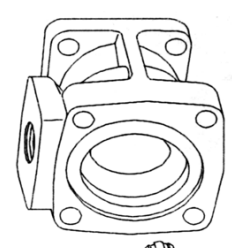

Bearing	
PART NO.	M8020030

Shaft seal	
PART NO.	M8020060
Type	NBR
	M8020065
	FPM

Seeger	
PART NO.	M8020050

Cover	
Model	STD
PART NO.	M8020121
	S
PART NO.	M8020120

Inlet body	
PART NO.	M8020115

Screw	
PART NO.	M6000130
Torque to 102 Nm (910 lb. in.)	

Screw	
PART NO.	M8020420
Torque to 70 Nm (624 lb. in.)	

Pump seal kit		
PART NO.	M6215500	Parts
	M6215510	seals + 2 shaft seals
		seals + 2 shaft seals
		FPM (Viton®)
		NBR

Id. codes of cartridge kit components

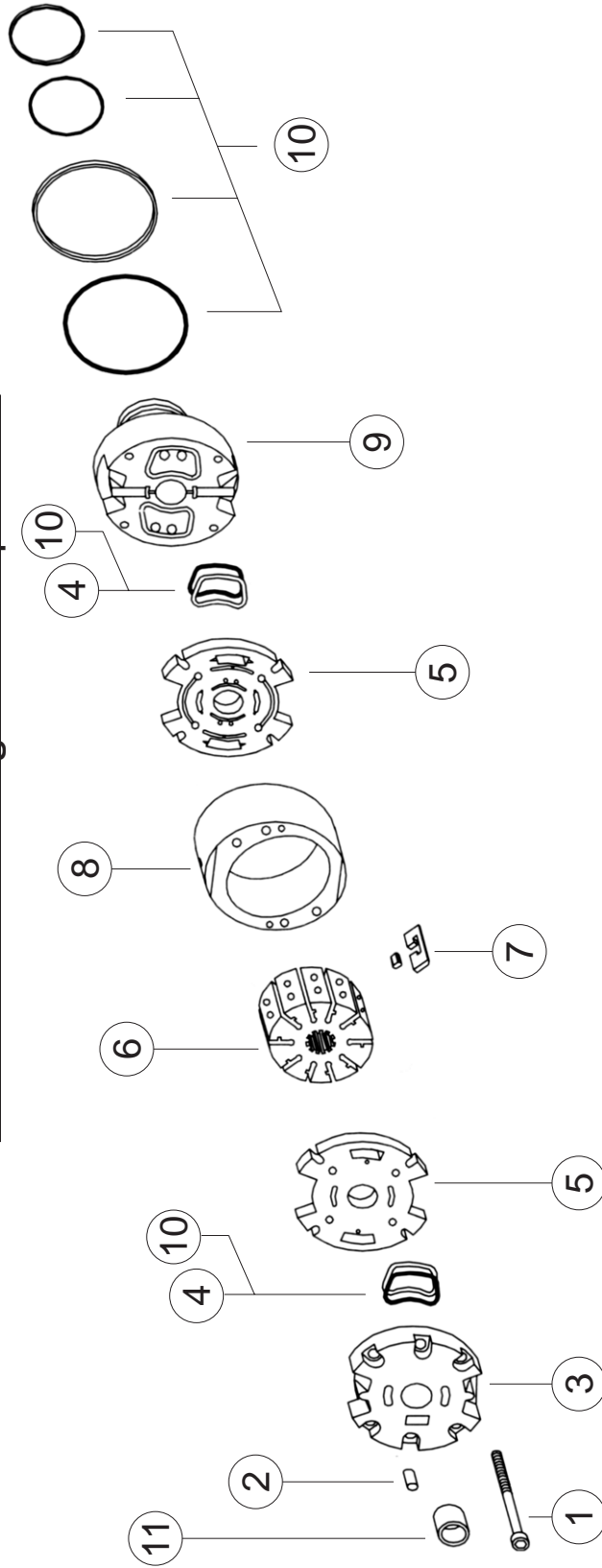

Cartridge Series Model	1	2	3	4	5	6	7	8	9	10	11
	Screw	Pin	Inlet support plate	Seal pack (4+4 pcs.)	Flex. plate kit (2 pcs.)	Rotor	Vane and insert kit (10+10 pcs.)	Ring	Outlet support plate	Seal kit (12 pcs.)	Bushing (*)
A01	02		L7209200			L7209300	L7209100	L7209002			
	05		L7209200			L7209300	L7209100	L7209005			
	08		L7209200			L7209300	L7209100	L7209008			
	09	L7200900	L7200800	L7209200	L7201300	L7209300	L7209100	L7209009	L7200100	L7201100	L7200600
	11	3,6 Nm (32 lb. in.)		L7200200		L7200300	L7201200	L7201011		L7202100 (FPM)	
	12			L7200200		L7200300	L7201200	L7201012			
A02	14		L7200200			L7200300	L7201200	L7201014			
	12							L7251012			
	14							L7251014			
	17	L7250900	L7250800	L7250200	L7251300	L7250300	L7251200	L7251017	L7250100	L7251100	L7250600
19	5,5 Nm (49 lb. in.)								L7252100 (FPM)		
21											
A03	24	L7300900	L7250200	L7251300	L7250715	L7300300	L7301200	L7301024	L7250100	L7251100	L7250600
	28	5,5 Nm						L7301028		L7252100 (FPM)	L7250600

(*) Note: the cover end cartridge of the double pump is without bushing.

Operating instructions

Maximum speed: the maximum speeds given in this catalogue are valid for an atmospheric pressure of 1 bar (14.7 psi) and with ambient temperature in the range of +30°C to +50°C. Higher speeds than those given cause a reduction in the volumetric efficiency, due to cavitation phenomena in the inlet area inside the pump. Sustained excess speed causes a rapid deterioration of the internal components reducing the lifetime of the cartridge.

Minimum speed: In general, the min. speed for all pumps is 600 rpm. However, it is possible to operate at lower speeds with certain pump configurations and with appropriate operating temperatures.

Inlet pressure: the inlet pressure, measured at the inlet port, should remain within the prescribed limits. Note that pressures lower than minimum limit cause cavitation and pressures above the maximum limit cause abnormal loads on the shaft and the bearings. In both cases this causes a significant reduction in the lifetime of the cartridge.

Maximum outlet pressure: the maximum outlet pressure is different for each type of fluid used as can be seen from the corresponding diagrams. With optimal temperature and filtration conditions a pressure peak of +10% is permissible for a maximum time of 0.5 sec.

Mounting and drive connections: consider the following indications when preparing the installation drawings for the system:

- avoid axial and radial loads on the shaft;
- the mounting flange has to be perpendicular to the drive shaft, with a maximum error of 0.18 mm every 100 mm;
- when mounting onto a gearbox, or other component without a flexible coupling, it is advisable to check the clearance between splines that has to be between 0.013 and 0.051 mm on the pitch diameter.

Hydraulic circuit: always install a pressure relief valve on the supply line to prevent the pressure from exceeding the allowed maximum. Normally, it is set in accordance with the weakest component in the system. (In the case where it is the pump, set the valve to a pressure 15% higher than the maximum pressure rating of the pump.) Inlet line tubing should have a section equal to or greater than that of the inlet port of the pump. It is advisable to keep the tube connecting the pump to the reservoir as short possible. Particular care has to be taken with the inlet line which has to be hermetically sealed to avoid entraining air into the circuit; this varies the characteristics of the hydraulic fluid causing the operating parts to become damaged.

Filtration: the inlet line filter must have a flow rate capacity that is higher than that of the pump at its maximum operating speed. The filtration requirements for individual models are given in this catalogue. The use of a filter bypass is recommended for cold starts and should the filter become clogged. Proper maintenance of the filter element is essential for the correct operation of the entire system. In normal conditions replace the filter element after the first 50 hours of operation. Subsequently, replace it at least every 500 hours. Regarding the filter on the return line, the same general conditions apply as for the inlet line and it should be positioned in an accessible location for ease of maintenance.

Tank: if possible, the reservoir should be positioned above the pump. Otherwise, ensure that the minimum level of the fluid contained in it is higher than the pump inlet line opening. It is important to avoid draining the inlet line with the pump at standstill. The opening of the return line into the reservoir must remain below the minimum level of the fluid in the reservoir. It must not be positioned too close to the opening of the inlet line to avoid the possibility of any air bubbles passing into the inlet line. Baffles inside the reservoir may be useful in avoiding the problem. Rapid temperature changes can cause condensation on the underside of the lid of the reservoir with the formation of droplets of water that can fall into the oil. To avoid this problem it is recommended that the lid should have small vents so that the air space in the reservoir is ventilated. The vents have to be screened, though, to prevent the entry of dust or the sudden expulsion of fluid.

Start-up: use the following procedure when the pump is started-up for the first time:
 completely fill the pump and the inlet line with fluid;
 start the engine for approximately one second a number of times at regular intervals of approximately 2 or 3 seconds until the noise level reduces, thereby confirming that it has been primed;
 with a manometer check to ensure that the outlet pressure increases slightly;
 once the pump has been primed, maintain low pressure levels activating all parts of the circuit a number of times until air bubbles disappear completely from the return line to the reservoir.
 This procedure should be carefully as any residual air inside the pump can quickly cause the rotor to seize.

Cold starting: when starting the pump, especially with low ambient temperatures, operate with moderate speed and pressure until the average temperature in the entire circuit is within the given limits.

The information provided in this catalogue is subject to change without notice